

DALI Repeater

Datasheet

Amplifier

Device to enhance the maximum
DALI cable length

Art. Nr. 86458401

Art. Nr. 86458401-PS

Art. Nr. 86458401-PS-HS



DALI Repeater Amplifier

Overview

- Device to enhance the maximum DALI cable length from 300m up to 600m.
 - Enhancement and Transmission of the DALI-signals (bidirectional).
 - Galvanic separation between DALI-circuits.
 - Either radially arranged network layout or cascaded system mounting operated with single master.
 - cascading (Series wiring) of up to 3 repeaters
 - The maximum amount of DALI-devices in the total network is limited to 64,
- the devices can be divided on the sub-circuits freely.
- For each subordinate DALI circuit, a separate bus power supply is needed. (DALI PS)
 - Type with integrated power supply available
 - Repeater PS: Test button for simple function check of all DALI bus ballasts.
 - Repeater PS: Module for DIN rail mounting and for remote ceiling installation available.

Specification, Characteristics

type	DALI Repeater		DALI Repeater PS	
article number	86458401		86458401-PS	86458401-PS-HS
input: L, N				
input type	none		supply, mains- voltage	
marking terminals	-		L, N	
input voltage range	-		100Vac ... 240Vac	110Vac ... 230Vac
max. input supply current	-		40mA (@120Vac), 20mA (@240Vac)	
input supply frequency	-		50Hz / 60Hz	
max. power consumption	-		5,3W	
startup time	-		250ms	
input: DA, DA				
input type	DALI control input			
marking terminals	DA, DA			
input voltage range	9,5V ... 22,5V			
current consumption DALI	6mA		2mA	
output: DA+, DA-				
output type	DALI		DALI / DALI supply	
marking terminals	DA, DA		DA+, DA-	
input voltage range	-		12Vdc ... 20,5Vdc	
guaranteed DALI supply current	-		200mA	
open circuit proof	yes		yes	

short circuit proof	yes	yes
---------------------	-----	-----

insulation data:

impulse voltage category	II
pollution degree	2
rated insulation voltage	250V
insulation DALI-output (DA+,DA-) / supply (L,N) DALI-input / DALI output(DA+, DA-) DALI-input / supply (L,N)	reinforced isolation
insulation test voltage DALI-output/mains	3000Vac

environmental conditions:

storing and transportation temperature	-20°C ... +75°C	
operational ambient temperature	-20°C ... +75°C	-20°C ... +60°C
rel. humidity, none condensing	15% ... 90%	

general data:

dimensions (l x w x h)	98mm x 17,5mm x 56mm	120mm x 41mm x 22mm	98mm x 17,5mm x 56mm
mounting	DIN rail integration in class II devices	remote ceiling integration in class II devices	DIN rail integration in class II devices
rated max. temperature tc	75°C	70°C	75°C
expected life time @tc	50.000 h		
protection class	II in intended use		
protection degree housing	IP40		
protection degree terminals	IP20		

terminals:

connection type	screw connector	spring terminal connector	screw connector
wire size solid core	0,5 ... 2,5 mm ² (AWG20 ... AWG14)	0,5 ... 1,5 mm ² (AWG20 ... AWG16)	0,5 ... 2,5 mm ² (AWG20 ... AWG14)
wire size stranded wired	0,5 ... 2,5 mm ² (AWG20 ... AWG14)	0,5 ... 1,5 mm ² (AWG20 ... AWG16)	0,5 ... 2,5 mm ² (AWG20 ... AWG14)
wire size using wire end ferrule	0,25 ... 1,5 mm ²	0,25 ... 1 mm ²	0,25 ... 1,5 mm ²
stripping length	7 mm / 0,27 inch	8,5 ... 9,5mm / 0,33 ... 0,37inch	7 mm / 0,27 inch
locking torque	0,5Nm	-	0,5Nm
release of wire	open screw	push button	open screw

standards:

DALI	EN 62386-101
EMC	EN 61547 EN 50015 / IEC CISPR15
safety	EN 61347-2-11 EN 61347-1
markings	CE

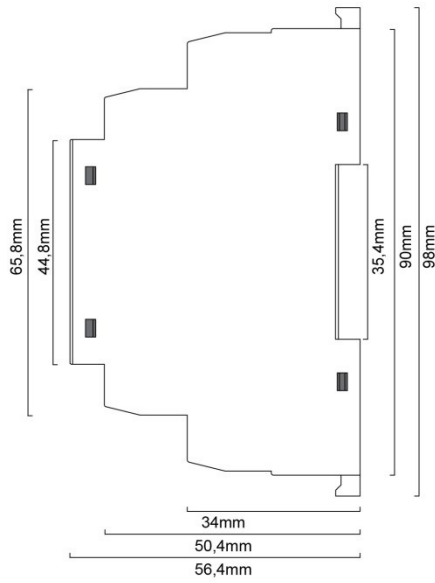

DALI Repeater
dimensions DIN rail module
Art Nr. 86458401

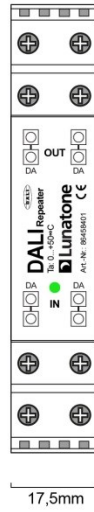

DALI Repeater
connection terminals DIN rail module
Art. Nr. 86458401

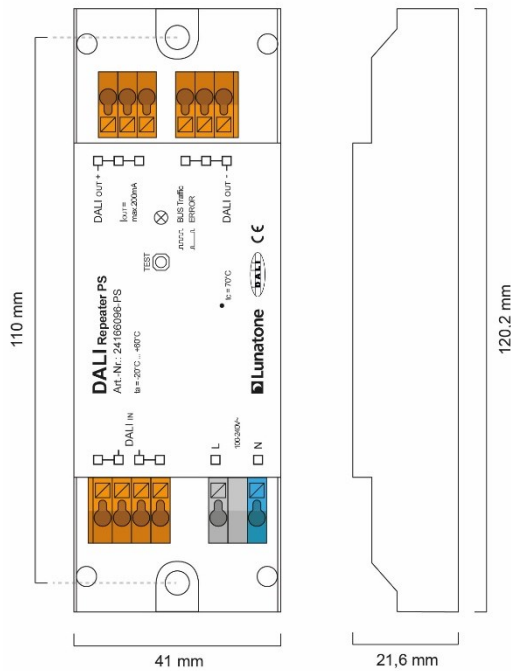

DALI Repeater PS
dimensions remote ceiling module
Art. Nr. 86458401-PS

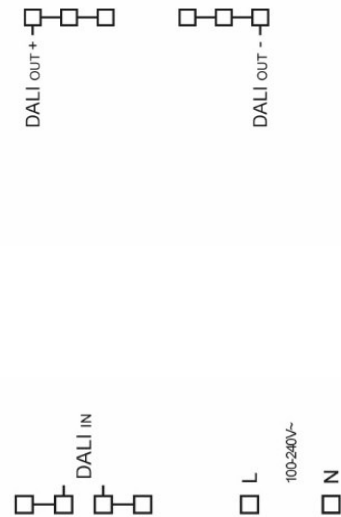

DALI Repeater PS
connection terminals remote ceiling module
Art. Nr. 86458401-PS

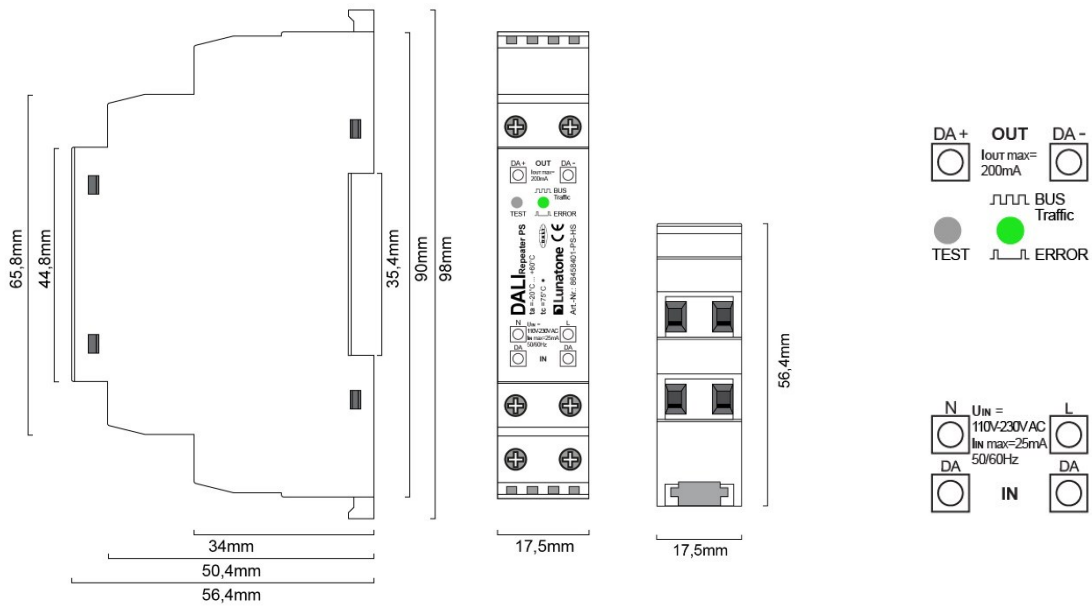

DALI Repeater PS HS
dimensions DIN rail module
Art. Nr. 86458401-PS-HS

DALI Repeater PS HS
Connection terminals
DIN rail module
Art. Nr. 86458401-PS-HS

Function

Figure 1 shows a typical application to increase the load on the DALI line: Dali commands from any control are transmitted in all DALI-lines, on the output of a DALI Repeater with integrated PS no DALI PS is needed.

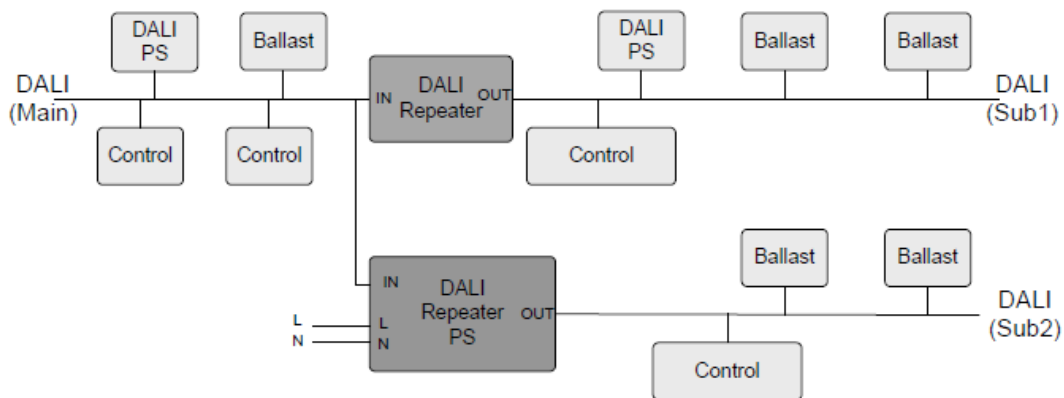

Figure. 1 application example: increase load on the DALI line

Figure 2 shows a typical application to extend the wiring length of the DALI installation. Cascading of up to 3 repeaters is possible (multi-master operation over several sections possibly restricted). The wiring must be carried out in the corresponding cable cross-section.

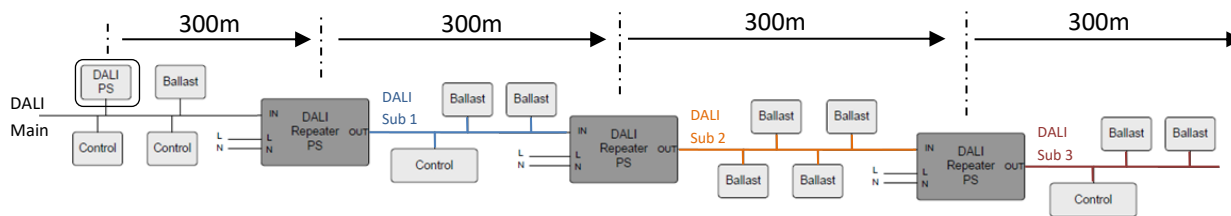





Figure. 2 application example: increase wiring length

Installation

- The DALI Repeater is intended for remote installation in the ceiling or in an enclosure, ensure proper cable relief for installation in protection class II devices.
 - The DALI Repeater HS-type is suited for DIN rail mounting. Ensure protection against electric shock by an appropriate enclosure.
 - Wiring as fixed installation in a dry and clean environment.
 - Installation only by qualified personal and when no voltage is applied.
 - Attend regulations regarding electrical installations of national authorities.
 - Repeater PS: connect power supply terminals L and N to mains voltage.
 - For Repeater PS please pay attention to the polarity of the output voltage marked on the housing (DA+, DA-).
 - The DALI-line may be installed within the same cable or as single conductors within the same tube as mains supply.
 - The DALI-line must not be connected to the mains or other SELV systems.
 - DALI-line wiring with standard low voltage installation material.
 - Wiring topology of the DALI-line: Line, Tree, Star
 - Repeater PS (86458401-PS und 86458401-PS-HS): Wiring check by pressing the test button: the LED is flashing, and all luminaires connected to the DALI system will be controlled by a test sequence (on, off, dimming). To quit the test mode: press the test button again.
 - Connect only one wire on each terminal if twin ferrules are used take care to the maximum wire size.
-  **HINT:** The DALI-signal is not classified as SELV circuit. Therefore, the standards for installation in low voltage system apply.
-  The voltage drop on the DALI line must not exceed 2V.
-  **HINT:** an improper DALI power supply can cause damage on DALI devices!

Commissioning

- After connection the DALI Repeater is ready for use.
- Make sure that the maximum power consumption of the DALI sub line does not exceed the guaranteed output current (200mA) of the Repeater PS.
- Status-LED:
 - flashing 5Hz, 50% on: test mode
 - flashing 2Hz, 5% on: error
 - flashing 2Hz, 90% on: activity

Purchase Information

Art. Nr. 86458401: DALI Repeater, DIN rail

Art. Nr. 86458401-PS: DALI Repeater, integrated power supply (200mA), remote ceiling

Art. Nr. 86458401-PS-HS: DALI Repeater, integrated power supply (200mA), DIN rail

Additional Information and Equipment

DALI-Cockpit – free configuration tool from Lunatone for DALI systems

http://lunatone.at/en/downloads/Lunatone_DALI-Cockpit.zip

Lunatone DALI products

<http://www.lunatone.at/en/>

Lunatone datasheets and manuals

<http://lunatone.at/en/downloads/>

Contact

Technical Support: support@lunatone.com

Requests: sales@lunatone.com

www.lunatone.com

Disclaimer

Subject to change. Information provided without guarantee.
The datasheet refers to the current delivery.

The compatibility with other devices must be tested in advance to the installation.