

## DALI MC4L

### Datasheet

**Multi Control Module with galvanic  
isolated switching inputs**

DALI control module with four  
programmable switching inputs for  
mains voltage

Art. Nr. 86458507-4L  
Art. Nr. 86458507-4LHS

# DALI MC4L Multi Control Module

## Overview

- DALI control module with 4 switching inputs for mains voltage
- galvanic isolation between switching input and DALI-line
- configurable function for each input
- destination address, switching mode and DALI-commands can be assigned to each input
- DALI DT8 support for adjustable white luminaires with the help of special macros
- adjustable „power-up“-function
- the function of the switching input can be configured with the help of the DALI Cockpit and a DALI USB interface
- multi-master capability, several modules can be installed on the same DALI-line
- suitable for installation in protection class II devices or back box installation



## Specification, Characteristics

type	DALI MC4L	DALI MC4L-HS
article number	86458507-4L	86458507-4LHS
<b>input: L1, L2, L3, L4, N</b>		
input type	switching input	
number of inputs	4	
marking input terminals	L1, L2, L3, L4, N	
input voltage range	230Vac	
tolerance of input voltage	+10%/-15%	
frequency of a.c. voltage	50Hz ... 60Hz	
control impulse length min.	40ms	
control impulse length for long press	>500ms	
input resistance	660kΩ	
wire length max.	10m	
max. voltage between inputs	230Vac	
<b>DALI interface, power supply: DA, DA</b>		
output type	DALI interface / power supply	
marking terminals	DA, DA	
voltage range	9,5Vdc ... 22,5Vdc (according to DALI)	
input current	3,5mA	
<b>insulation data:</b>		
impulse voltage category	II	

pollution degree	2
rated insulation voltage	250V
rated impulse withstanding voltage	4kV
insulation DALI / mains	reinforced isolation
insulation test voltage DALI / mains	3000Vac

**environmental conditions:**

storing and transportation temperature	-20°C ... +75°C
operational ambient temperature	-20°C ... +75°C
rel. humidity, none condensing	15% ... 90%

**general data:**

dimensions (l x w x h)	59mm x 33mm x 15mm	98mm x 17,5mm x 56mm
mounting	back box installation installation in protection class II devices	dinrail, built-in
rated maximum temperature tc	75°C	
expected life time @tc	50.000 h	
protection class	II in intended use	
protection degree housing	IP40	
protection degree terminals	IP20	

**terminals:**

connection type	spring terminal connectors	screw terminal
wire size solid core	0,5 ... 1,5 mm <sup>2</sup> (AWG20 ... AWG16)	0,5 ... 2,5 mm <sup>2</sup> (AWG20 ... AWG14)
wire size fine wired	0,5 ... 1,5 mm <sup>2</sup> (AWG20 ... AWG16)	0,5 ... 2,5 mm <sup>2</sup> (AWG20 ... AWG14)
wire size using wire end ferrule	0,25 ... 1 mm <sup>2</sup>	0,25 ... 1,5 mm <sup>2</sup>
stripping length	8,5 ... 9,5 mm / 0,33 ... 0,37 inch	7 mm / 0,27 inch
tightening torque	-	0,5Nm
release of wire	push button	open screw

**standards::**

EMC	EN 61547 EN 50015 / IEC CISPR15	
safety	EN 61347-2-11 EN 61347-1	
markings	ENEC-11, cURus, CE	cURus, CE
UL file number	E495950	

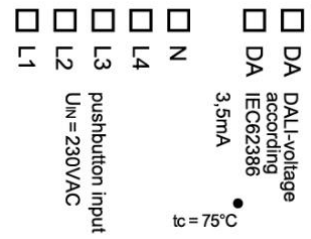
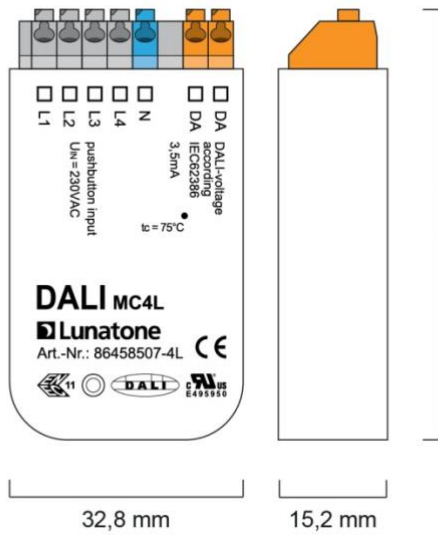

connectors MC4L

dimensions MC4L

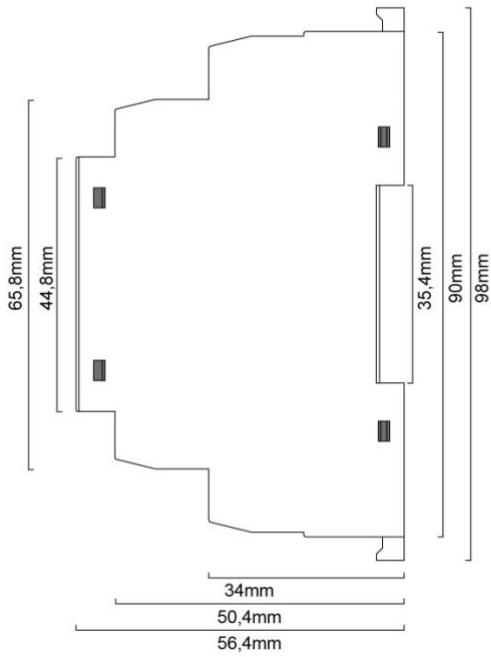

dimensions MC4L-HS

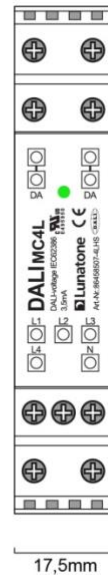

connectors MC4L-HS

## Installation

- The DALI MC4L is intended for back box installation or for integration in protection class 2 devices
- Ensure proper working cable relief for installation in protection class II equipment
- The DALI MC4L-HS is suitable for dinrail mounting, protection against electric shock has to be ensured by an appropriate enclosure
- Wiring as fixed installation in a dry and clean environment
- Installation only by qualified person when no voltage is applied
- Attend regulations regarding electrical installations of national authorities
- the DALI MC4L/MC4L-HS is powered by the DALI-line – no separate power supply needed
- the connection to the DALI-line is polarity free
- DALI-line wiring with standard low voltage installation material
- The DALI-interface can handle mains voltage, protecting the device in case of wrong wiring
- Wiring topology of the DALI-line: Line, Tree, Star
- Switching inputs are intended for use with line voltage, they are galvanic separated from the DALI-line
- Line voltage shall be fused appropriate to the cross section of the wiring, we recommend a fuse or circuit breaker to be placed in the electrical circuit (mains voltage)
- Connect only one wire on each terminal, if twin ferrules are used take care to the maximum wire size



**HINT:** The DALI-signal is not classified as SELV circuit. Therefore the standards for installation in low voltage system apply.



The DALI-Circuit in its full length shall not exceed a voltage drop of more than 2V.

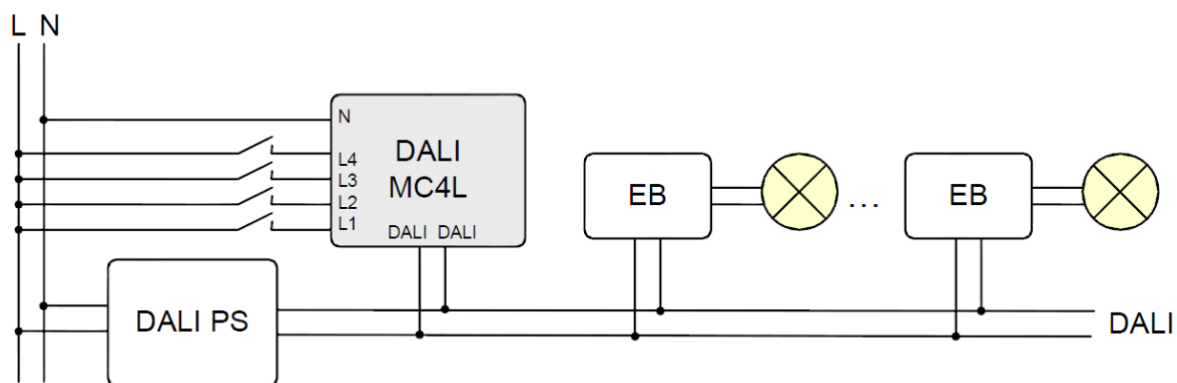

wiring diagram

## Commissioning

(interface module to DALI-line required, e.g. DALI USB, DALI SCI RS232, DALI4Net)

- After installation the DALI MC4L can already be used with the factory default settings:
  - Input L1: Recall Max (Broadcast)
  - Input L2: Up (Broadcast)
  - Input L3: Off (Broadcast)
  - Input L4: Down (Broadcast)
- The configuration can be adapted with the help of the DALI-Cockpit software
- The DALI MC4L is automatically detected during the addressing procedure and is then shown in the component tree
- The DALI MC4L can be selected and the desired function can be configured, the settings are separated in 3 parts: target address, function and command selection

### Input Tab:

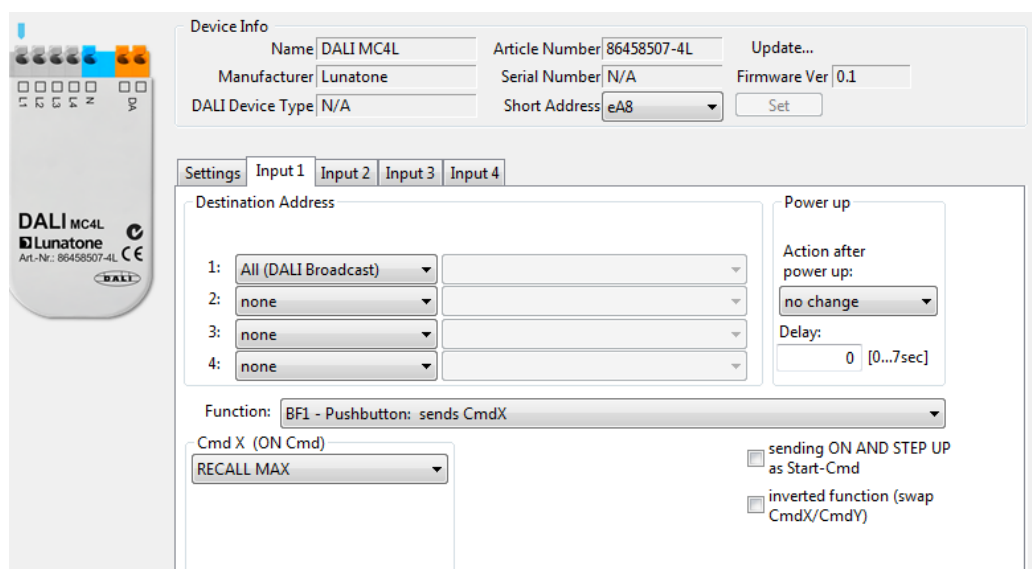

### Selection target address (target destination)

Option	Event: key press
All (DALI Broadcast)	Send command to all devices on the bus
Group G0 ... G15	Send command to the selected group
Single Address A0 ... A63	Send command to the selected address

Settings for Button Function:

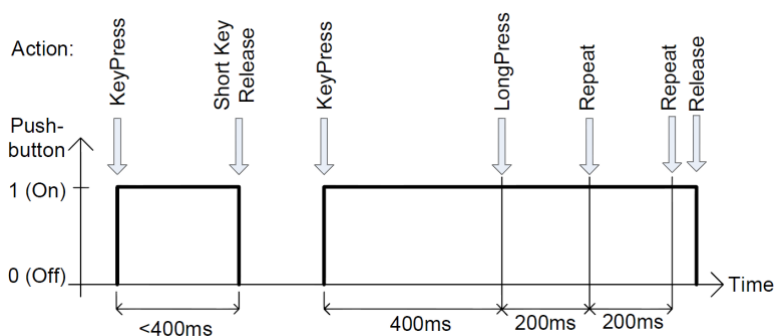

Definition:

button definition	duration	
	min	max
short	40 ms	400 ms
long	>400 ms	

button function number	event: key press	event: release after short press	event: long press	event: repeat	function	typical application
0	-	-	-	-	-	
1	CmdX	-	-	-	sends CmdX on key press	master off
2	CmdX	-	CmdY	-	sends CmdX on key press sends CmdY after long press delay	switch to 2 different levels
3	CmdX	-	CmdY	CmdY	sends CmdX on key press sends CmdY with 200ms repetition after long press delay	switch on and dim
4	CmdX / CmdY toggle	-	-	-	sends CmdX and CmdY alternating on key press	toggle push button (impulse switch)
5	CmdX / CmdY toggle	-	-	-	CmdX/Y <b>depending on bus status</b>	changeover push button
6	-	CmdX / CmdY toggle	ON and STEPUP	UP / DOWN	CmdX/Y <b>depending on bus status</b> , UP/DOWN alternating, ON AND STEPUP, if bus state is OFF before UP	push and dim button
7	CmdX	CmdY (any release)	-	-	sends CmdX on press ("switch on"-transition), sends CmdY on release ("switch off"-transition)	switch
8	CmdX / CmdY toggle	CmdX / CmdY toggle (any release)	-	-	sends CmdX/Y on press or release ("switch on/off"-transition) <b>depending on bus status</b>	changeover switch
9	CmdX	-	-	-	Staircase control. CmdY is sent after a programmable delay.	staircase control
10	-	CmdX	CmdY	CmdY	CmdX after short press, CmdY for repeat	push and dim button
11	CmdX	-	-	CmdY	Sends CmdX; repeats CmdY without long press delay	push and dim button
12	CmdX	CmdY	-	CmdX	CmdX with repeat; if button is released within short press time, CmdY is finally sent	dim button

### Settings for CmdX/CmdY

CmdX and CmdY are commands or a set of commands, which are sent at the defined button utilisation. Available commands:

- DALI commands
- predefined macros (sequence of commands)
- user defined macros

#### DALI-Commands:

Command number	Command name	function
-	DIRECT ARC POWER	direct arc power Level in %
0	OFF	off
1	UP	dim up (using fade rate)
2	DOWN	dim down (using fade rate)
3	STEP UP	increases light level by one increment
4	STEP DOWN	decreases light level by one increment
5	RECALL MAX	recalls MAX value
6	RECALL MIN	recalls MIN value
7	STEP DOWN AND OFF	decreases light level by one increment, if value at MIN switch off
8	ON AND STEP UP	increases light level by one increment, if OFF switch on
10	GOTO LAST ACTIVE LEVEL (DALI-2)	DALI-2-Cmd for switching on to the last active level (Memory-Function)
16-31	GO TO SCENE	go to scene 0-15

#### Macros:

Nr	macro (required memory)	function
M1	Go Home (2 Byte)	Light dims down to DAP 0 with predefined fade time, then fade time is set back to a programmable value
M2	Sequential Scenes (3Byte)	Selectable scenes (or OFF) will be sent sequentially with each button press.
M3	Dynamic Scenes (33 Byte)	Dynamic sequence of up to 16 selectable scenes, fadetimes and delays, stops with next button press
M4	DALI-Reset (1 Byte)	Sends DALI-Reset (address can be deleted optionally)
M5	User Defined Cmd-List (5 Byte je Befehl, 19 Befehle max.)	A user defined macro file can be loaded to the switch (only commands to DALI control gear (16-Bit forward frames) supported)
M6	3x Cooler (DT8) (0 Byte)	Activates DT8 and sends STEP COOLER command 3x
M7	3x Warmer (DT8) (0 Byte)	Activates DT8 and sends STEP WARMER command 3x
M8	Memory Switch On (4 Byte)	MEMORY FUNCTION Switches to last recent level, works only in combination with Switch Off
M9	Memory Switch Off (3 Byte)	MEMORY FUNCTION Stores last recent level and switches off



M10	Memory Dim Up (after Switch Off) (3 Byte)	MEMORY FUNCTION Allows to Dim Up from Off-State to MAXLEVEL, when having used Switch Off before
-----	---	--



**Hint:** The limit for the maximum number of commands in macros is 19. This limit applies to the accumulated number of CmdX and CmdY macros.

*Power Up Function:*

Another configurable feature is the “power-up”-function. This is a user-defined reaction on a power up on the DALI Bus. The following options are available:

reaction after Power Up	Adjustable delay time
no action	0 ... 7 seconds
OFF	0 ... 7 seconds
GOTO SCENE 0-15	0 ... 7 seconds

To take the startup-time of DALI-ballasts into account, a delay time can be configured between power up and the start of transmission of the selected command.

**Purchase Information**

**Art.Nr. 86458507-4L:** DALI MC4L, DALI control device with 4 switching inputs for mains voltage, back box installation and class II device integration

**Art.Nr. 86458507-4LHS:** DALI MC4L, DALI control device with 4 switching inputs for mains voltage, din rail mounting, built in

**Contact**

Technical Support: [support@lunatone.com](mailto:support@lunatone.com)

Requests: [sales@lunatone.com](mailto:sales@lunatone.com)

[www.lunatone.com](http://www.lunatone.com)



**Additional Information and Equipment**

Lunatone datasheets and manuals  
<https://www.lunatone.com/en/downloads-a-z/>

Lunatone DALI products  
<https://www.lunatone.com/en/>

**Disclaimer**

Subject to change. Information provided without guarantee. The datasheet refers to the current delivery.

The compatibility with other devices must be tested in advance to the installation.