

DALI 3Ch LED Dimmer CV

Datasheet Control Gear



3-channel LED Dimmer (CV, DT6)



Art. Nr. 89453828 (4A)

Art. Nr. 89453834 (8A)

Art. Nr. 86459571 (10A)

Art. Nr. 89453831 (16A)

Art. Nr. 89453831-HS (16A DIN Rail)

DALI 3Ch LED Dimmer CV Control Gear

Overview

- 3 channel DALI LED-Dimmer
- suitable for constant voltage LED-modules with operating voltages from 12V to 48V
- **Operating Mode DT6:** individual channel control via 3 DALI addresses
- **Operating Mode Colour&Dim:** control by 2 DALI-addresses, one for adjusting the light level and one for adjusting the colour
- **SwitchDim2:** 2 switch-inputs offer control of light level and colour without DALI
- dimming range 0.1%-100%
- adjustable PWM-frequency (122Hz/ 244Hz/ 488Hz/ 976Hz from FW version 4.6 on changed PWM frequencies: 250Hz / 500Hz / 1kHz)
- compact types for integration in luminaires and remote ceiling
- supply voltage 12V to 48V DC (according to the operating voltage of the led modules)
- type dependent max. input currents of 4A, 8A, 10A or 16A
- the maximum input current can be freely distributed between the channels (max 10A per channel)
- low standby power consumption
- high efficiency
- configuration via PC-software DALI-Cockpit and DALI USB-interface
- user-friendly factory default settings

From FW Version 4.6 onward:

- DALI-2 compatible
- LED calibration for light adjustment
- Configurable RESET behaviour



Specification, Characteristics

type	DALI 3Ch LED Dimmer				
article number	89453828	89453834	89459571	89453831	89453831-HS
electrical data:					
supply voltage	12VDC-48VDC				
maximum input current I _{in_max}	4A	8A	10A	16A	
control input	DALI SwitchDim2 (mains voltage)				
current consumption DALI	2mA				
number of DALI-addresses	operating mode DT6: 3 operating mode Colour&Dim: 2				
standby power consumption (12V)	~ 120mW				
technical data:					
power on behaviour	configurable: 0%-100% or last value				
storing- and transportation temperature	-20°C ... +75°C				
ambient temperature	-20°C to +60°C			-20°C to +55°C	

article number	89453828	89453834	89459571	89453831	89453831-HS
expected lifetime (at Tc<=75°C)	>100000h				
protection class	IP20				
max. connecting wire cross section	1.5 mm ²	2.5 mm ² / DALI&SwD: 1.5 mm ²		2.5mm ²	
dimensions (LxWxH)	60x33x15 mm	120x30x22 mm		98x18x56 mm	
housing/mounting	back box	remote ceiling		DIN rail	

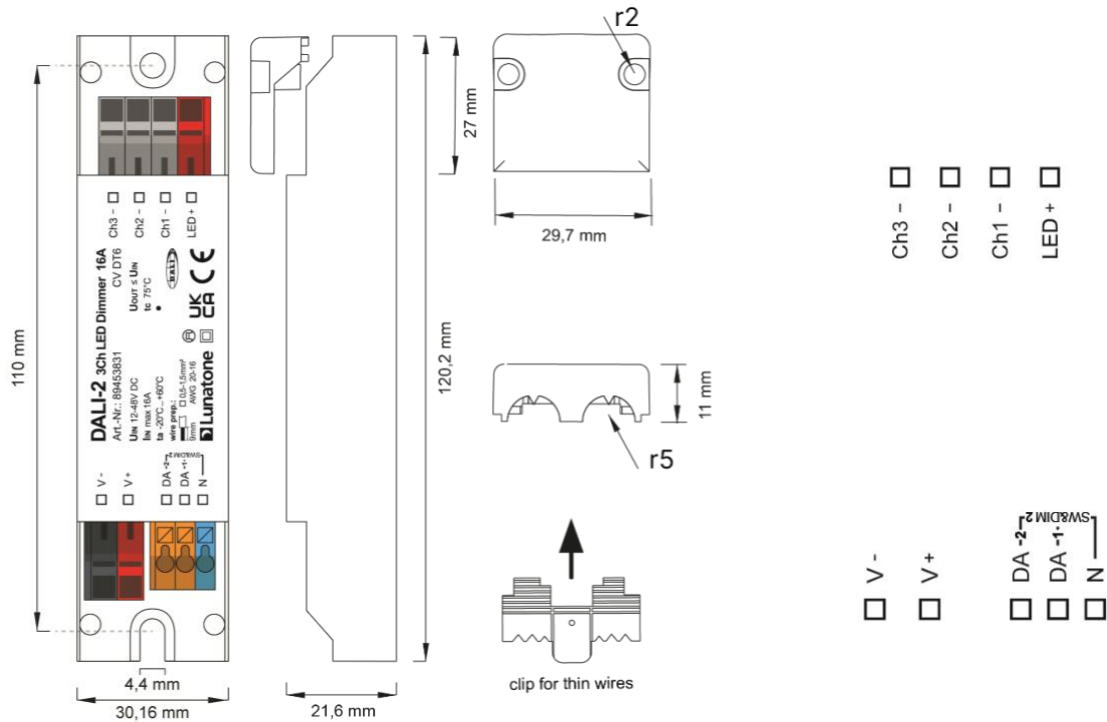

dimensions remote ceiling
Version 16A Art.Nr.: 89453831
Version 10A Art.Nr.: 86459571

connection plan remote ceiling
Version 16A Art.Nr.: 89453831
Version 10A Art.Nr.: 86459571

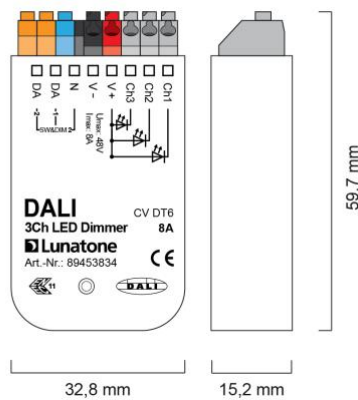

dimensions back box
Version 8A Art.Nr.: 89453834
Version 4A Art. Nr.: 89453828

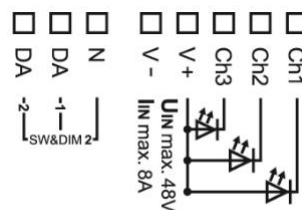

connection plan back box
Version 8A Art.Nr.: 89453834
Version 4A Art. Nr.: 89453828

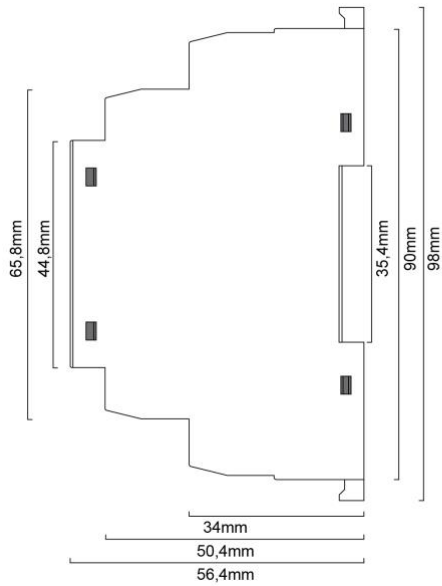

dimensions DIN rail housing
Version 16A Art.Nr.: 89453831-HS

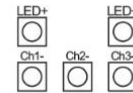
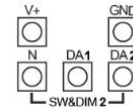

connection DIN rail housing
Version 16A Art.Nr.: 89453831-HS

RECOMMENDATION: Care should be taken on keeping cable lengths between DC power supply and dimmer, as well as between dimmer and luminaires (Led-Strings), as short as possible. This kind of installation will minimize the influence of voltage drops.

Control via DALI (all device versions):

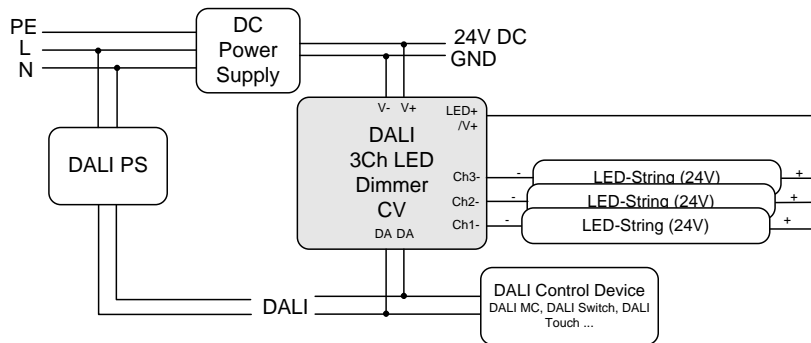

Control via SwitchDim2 (all device versions):

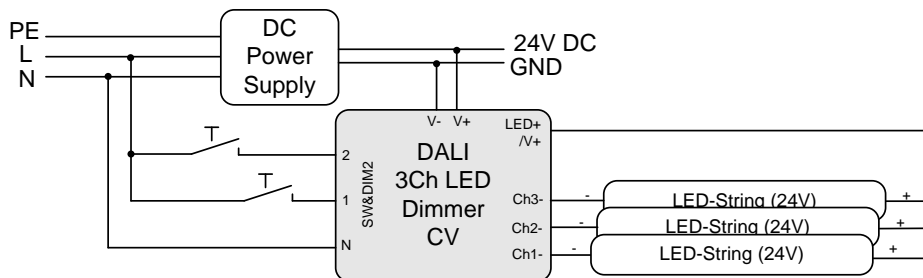

Operating Modes

The device offers two operating modes DT6 and Colour&Dim.

DT6 (factory default)

In this operating mode each channel can be controlled by its own DALI address (Device Type 6).

Alternatively, the device can be controlled using 2 switch-inputs for mains voltage (SwitchDim2):

SwD1: light level

short press: On/Off

long press: dimming

SwD2: scene selector (short press)

scene pre-set see table 1, page 8.

From FW version 4.6 on Lunatone LED Dimmer are DALI 2 compatible and support DALI 2 commands.

Colour&Dim

This operating mode is suitable for operating RGB—luminaires. Two DALI-addresses are used, the first address to control the light level and the second address to change the distribution on the output channels (e.g. for colour adjustments).

The Colour&Dim mode allows colour adjustments without affecting the light level and vice versa. For each channel DALI-standard commands like dim up/down and DAP are used. Thus, the device can be used with all common controls and gateways (e.g. KNX). The Colour&Dim mode provides an alternative to the DT8-RGBWAF device.

Can be operated via DALI or SwitchDim2:

DALI-address 1, SwD1: light level

DALI-address 2, SwD2: colour

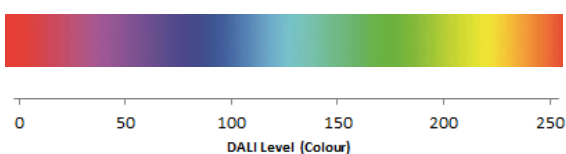

Selection of the operating mode

With the help of the PC-software tool DALI-Cockpit the operating mode can be easily set on the overview page.

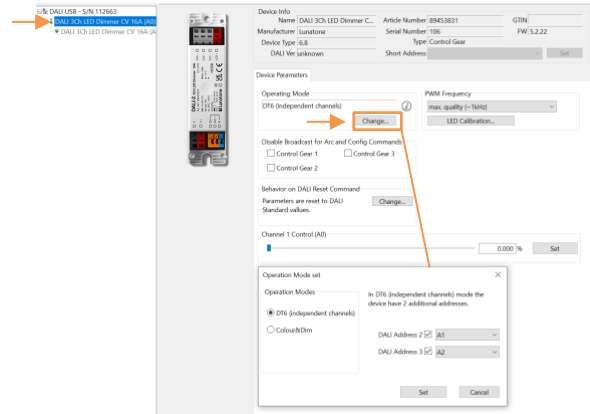

The operating mode can also be set with the DALI-command: SET OPERATING MODE (IEC 62386-102 Ed.2). When changing the operating mode, the number of used DALI-addresses might change as well, which requires a new addressing process. In the DALI-Cockpit this address assignment is performed automatically.

Operating Mode:

Number	Operating Mode
0	DT6 (factory default)
0x90	DT6
0x93	Colour&Dim

Cockpit: General Settings

On the overview page, there are different control elements, depending on the operating mode (DT6: 3 sliders for the level of each channel, Colour&Dim: a slider for level and a slider for colour). Also, the following configuration options are available.

Overview operating mode DT6:

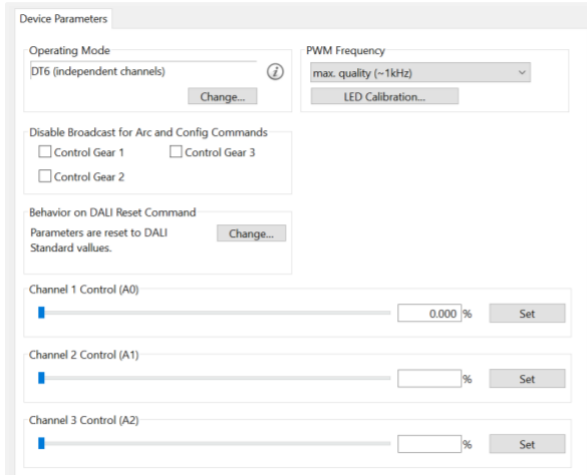

Overview operating mode Colour&Dim:

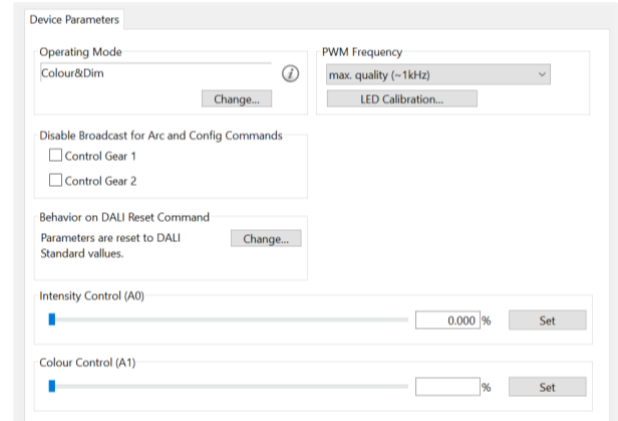

When activated the device does not react to **broadcast Arc (DAP)** or configuration commands.

Setting the light value to be calibrated

Set the light value and start the adjustment.

Fine adjustment of light value - direct feedback for comparison between lights

Figure 1 Cockpit Overview page - LED calibration and behaviour on DALI Reset Command

The **PWM frequency** can be selected:
122Hz / 244Hz / 488Hz / 976Hz.

From FW version 4.6 changed PWM frequencies: 250Hz / 500Hz / 1kHz.

The **broadcast control** can be deactivated for each channel individually.

Adjustable RESET behaviour:

From FW version 4.6 up the response to a DALI reset command is configurable. The following options are available:

- *Ignore command*: the DALI reset command does not trigger any changes to the device settings.
- *DALI standard*: the selected device settings are reset to the values defined in the DALI standard (see table 1 below - second column: DALI standard values)

Calibration - light adjustment:

The dimming range extends from 0.1% to 100%. From FW version 4.6 on, it is possible to calibrate different light sources, with the option: LED calibration. For each channel, the MIN level (default: 0.1%) an intermediate value (default: 33%) and the MAX level (default: 100%) can be adjusted and matched between light sources.

To do this, set the desired level with the upper slider. Apply the value and start the fine adjustment by pressing the button next to it. The appropriate fine adjustments can now be made with the calibration slider below.

See also Figure 1 on page 6.

Cockpit: Additional Settings

Besides the settings on the general page each channel can be selected separately in the component tree for individual configuration.

Component Tree:

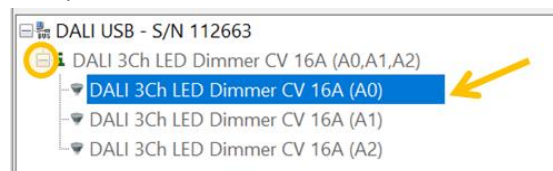

Figure 2 below shows the available settings for each channel (these are the same for all operating modes). For each address the group membership, scene values and DALI-parameters can be set. In Colour&Dim operating mode, channel 2 sets colours.

Factory Default Settings

Before the initial addressing is performed, the device can already be controlled by group addresses. This predefined grouping will be deleted during the first addressing procedure. Afterwards groups can be assigned as usual (e.g. with the DALI Cockpit). By sending a DALI-Reset command the device is set to DALI default values as defined in the standard.

The factory default values as well as DALI-standard values are summarised in table 1 below.

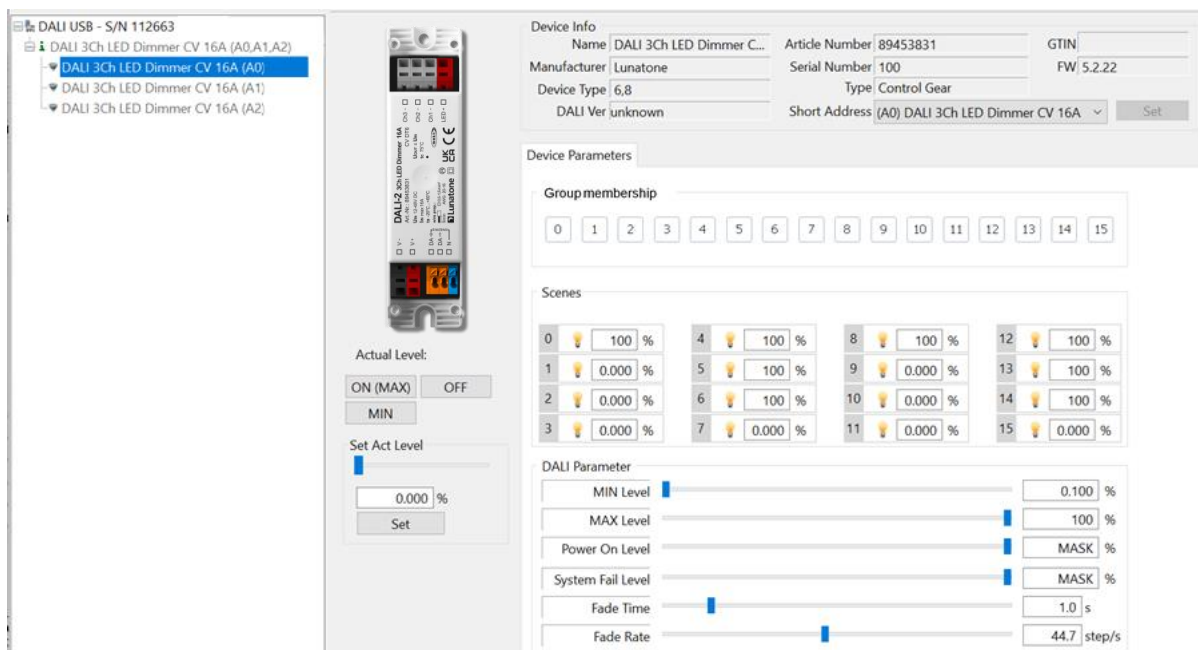

Figure 2 Cockpit Settings for each channel / address

Summary of the factory default settings (delivery state):

	Factory default	DALI Standard																																				
operating mode	DT6	---																																				
switchDim2	SwD1: light level SwD2: scene selector	---																																				
Min Level	0.1%	0.1%																																				
Max Level	100%	100%																																				
Power On Level	MASK (last value)	100%																																				
System Failure Level	100%	100%																																				
Fade Time	1s	None																																				
Fade Rate	89.4 steps/s	44.7 steps/s																																				
PWM-Frequency	122Hz or 1kHz for FW 4.6 and up	---																																				
Groups before initial addressing	G0 – channel1 G1 – channel2 G2 – channel3	None																																				
Scene values	<table border="1"> <thead> <tr> <th>Scene</th> <th>Ch1</th> <th>Ch2</th> <th>Ch3</th> </tr> </thead> <tbody> <tr><td>0, 8</td><td>100%</td><td>0%</td><td>0%</td></tr> <tr><td>1, 9</td><td>0%</td><td>100%</td><td>0%</td></tr> <tr><td>2, 10</td><td>0%</td><td>0%</td><td>100%</td></tr> <tr><td>3, 11</td><td>0%</td><td>100%</td><td>100%</td></tr> <tr><td>4, 12</td><td>100%</td><td>0%</td><td>100%</td></tr> <tr><td>5, 13</td><td>100%</td><td>100%</td><td>0%</td></tr> <tr><td>6, 14</td><td>100%</td><td>100%</td><td>100%</td></tr> <tr><td>7, 15</td><td>0%</td><td>0%</td><td>0%</td></tr> </tbody> </table>	Scene	Ch1	Ch2	Ch3	0, 8	100%	0%	0%	1, 9	0%	100%	0%	2, 10	0%	0%	100%	3, 11	0%	100%	100%	4, 12	100%	0%	100%	5, 13	100%	100%	0%	6, 14	100%	100%	100%	7, 15	0%	0%	0%	all scenes: MASK
Scene	Ch1	Ch2	Ch3																																			
0, 8	100%	0%	0%																																			
1, 9	0%	100%	0%																																			
2, 10	0%	0%	100%																																			
3, 11	0%	100%	100%																																			
4, 12	100%	0%	100%																																			
5, 13	100%	100%	0%																																			
6, 14	100%	100%	100%																																			
7, 15	0%	0%	0%																																			
Behaviour at DALI RESET command	set DALI Standard values, see column 2	---																																				

Table 1 factory default settings column 1, DALI Standard settings column 2

Purchase Order Information

Art.Nr. 89453828: 3-channel LED Dimmer, CV, max. input current 4A, 12V-48V DC, back box

Art.Nr. 89453834: 3-channel LED Dimmer, CV, max. input current 8A, 12V-48V DC, back box

Art.Nr. 86459571: 3-channel LED Dimmer, CV, max. input current 10A, 12V-48V DC, SwitchDim2, remote ceiling & integration in luminaires

Art.Nr. 89453831: 3-channel LED Dimmer, CV, max. input current 16A, 12V-48V DC, SwitchDim2, remote ceiling & integration in luminaires

Art.Nr. 89453831-HS (16A DIN Rail):
3-channel LED Dimmer, CV, max. input current 16A, 12V-48V DC, SwitchDim2, DIN rail housing

Additional Information and Equipment

Lunatone DALI Cockpit

<https://www.lunatone.com/en/product/dali-cockpit/>

Lunatone datasheets and manuals

<https://www.lunatone.com/en/downloads-a-z/>

Lunatone DALI products

<https://www.lunatone.com/en/>

Contact

Technical Support: support@lunatone.com

Requests: sales@lunatone.com

www.lunatone.com



Disclaimer

Subject to change. Information provided without guarantee.
The datasheet refers to the current delivery.

The compatibility with other devices must be tested in advance to the installation.