

Zugentlastung

Art.Nr.: 00000026

einfache Handhabung, zuverlässiger Halt und kabelschonend,
 passend für Deckeneinwurfgehäuse: 120mmx30mmx22mm
 Set mit 4 Teilen + 4 Schrauben

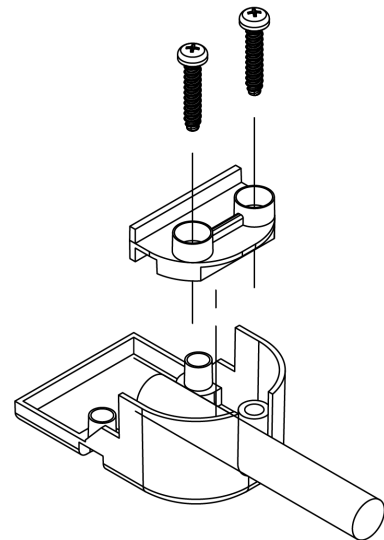
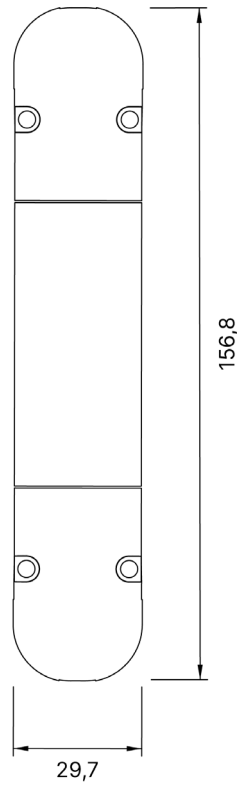

Gehäuseabdeckung

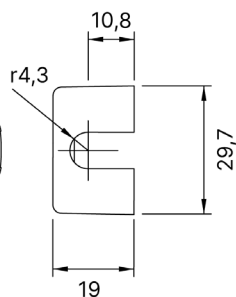
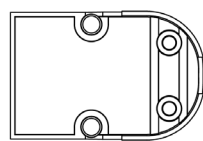
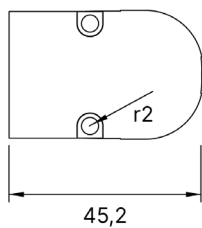
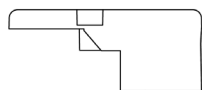
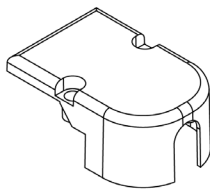

Einsatz zur Anpassung der Klemmstärke

