

## DALI-2 Expander

### Datasheet

#### DALI System Extension

device for simple  
DALI line expansion  
with integrated  
Bus power supply



Art. Nr. 89452937-DO  
Art. Nr. 89452937-DES  
Art. Nr. 89452937-HS



# DALI-2 Expander DALI System Extension

## Overview

- Device for simple DALI line expansion
- Control of several DALI-devices via one DALI-address
- For the superordinate DALI line, the DALI-2 Expander acts as a DALI ballast (DALI IN) with a single address
- Output (DALI OUT) with DALI power supply (200mA) for the supply of DALI EVG's and DALI control modules
- Forwarding commands received at the input (DALI IN) to the output (DALI OUT) broadcast.
- Alternative control options of the DALI-output line via Switch&Dim-input (Broadcast)
- Available for DIN rail mounting (for integration in protection class II devices) or as independent control gear (for remote ceiling or integration in luminaires)
- DALI-2 certified version of the DALI Expander (art.nr. 89443847)



## Specification, Characteristics

type	DALI-2 Expander installation box	DALI-2 Expander remote ceiling	DALI-2 Expander DIN rail
article number	89452937-DO	89452937-DES	89452937-HS

### input: L, N

input type	supply, mains- voltage		
marking terminals	L, N		
input voltage range	120Vac ... 240Vac	120Vac ... 240Vac	
max. input supply current	20mA (@120Vac), 10mA (@240Vac)	40mA (@120Vac), 20mA (@240Vac)	
input supply frequency	50Hz / 60Hz		
max. power consumption	3W	5,3W	
start-up time	250ms		

### input: DA, DA

input type	DALI control input		
marking terminals	DA, DA		
input voltage range	9,5V ... 22,5V		
max. current consumption DALI	2mA		

article number	89452937-DO	89452937-DES	89452937-HS
----------------	-------------	--------------	-------------

**input: L', N**

input type	-	SwitchDim - control input	
marking terminals	-	L', N	
input voltage range	-	230Vac	
input supply frequency	-	50Hz/60Hz	
control impulse length min.	-	40ms	
control impulse length long press	-	500ms	
max. wire length	-	10m - 15m, depending on type of installation and interference fields.	

**output: DA+, DA-**

output type	DALI supply		
marking terminals	DA+, DA-		
output voltage range	12Vdc ... 20,5Vdc		
guaranteed output current	25mA	200mA	
Maximum output current	250mA	250mA	
open circuit proof	yes		
short circuit proof	yes		

**insulation data:**

impulse voltage category	II		
pollution degree	2		
rated insulation voltage	250V		
insulation DALI-output (DA+, DA-) / supply (L, N) DALI-input / supply (L, N)	reinforced isolation		
insulation DALI- input / DALI-output (DA+, DA-)	-	-	reinforced isolation
insulation test voltage DALI-output/mains	3000Vac		

**environmental conditions:**

storing and transportation temperature	-20°C ... +75°C		
operational ambient temperature	-20°C ... +55°C	-20°C ... +60°C	-20°C ... +55°C
rel. humidity, none condensing	15% ... 90%		

**general data:**

dimensions (l x w x h)	59mm x 33mm x 15mm	120mm x 30mm x 22mm	98mm x 17,5mm x 56mm
mounting	Installation box, integration in class II devices	remote ceiling, integration in class II devices	DIN rail, integration in class II devices
rated max. temperature tc	70°C		75°C
expected lifetime @tc	50.000 h		
protection class	II in intended use		
protection degree housing	IP40		IP40
protection degree terminals	IP20		IP20

article number	89452937-DO	89452937-DES	89452937-HS
----------------	-------------	--------------	-------------

**terminals:**

connection type	spring terminal connector	screw connector
wire size solid core	0,5 ... 1,5 mm <sup>2</sup> (AWG20 ... AWG16)	0,5 ... 2,5 mm <sup>2</sup> (AWG20 ... AWG14)
Wire size stranded wired	0,5 ... 1,5 mm <sup>2</sup> (AWG20 ... AWG16)	0,5 ... 2,5 mm <sup>2</sup> (AWG20 ... AWG14)
wire size using wire end ferrule	0,25 ... 1 mm <sup>2</sup>	0,25 ... 1,5 mm <sup>2</sup>
stripping length	8,5 ... 9,5mm / 0,33 ... 0,37inch	7 mm / 0,27 inch
locking torque	-	0,5Nm
release of wire	push button	open screw

**standards:**

DALI	EN 62386-101
EMC	EN 61547 EN 50015 / IEC CISPR15
safety	EN 61347-2-11 EN 61347-1
markings	DALI-2, CE, UKCA

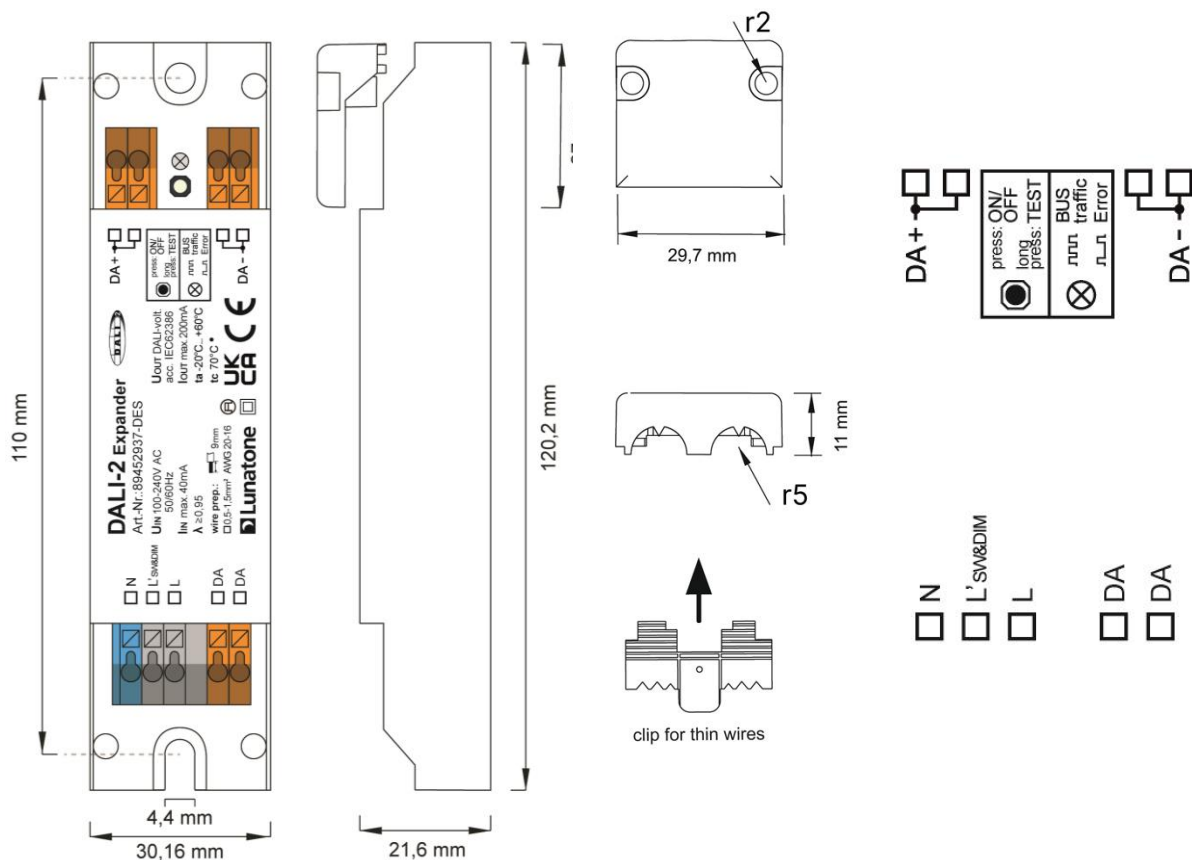

dimensions DALI-2 Expander  
Art.Nr.: 89452937-DES

standard strain relief  
cover for  
120x30x22mm

connection terminals  
DALI-2 Expander  
Art.Nr.: 89452937

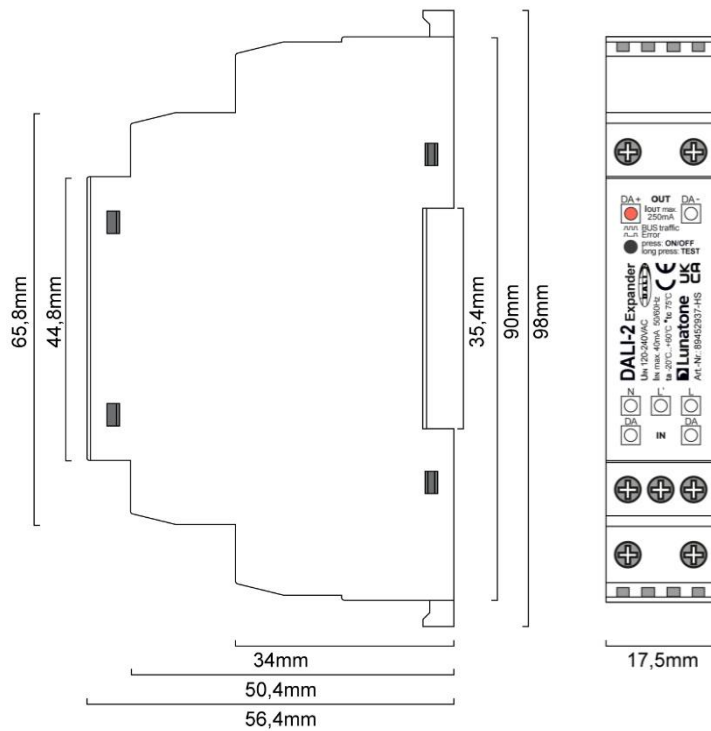

dimensions DALI-2 Expander HS  
89452937-HS

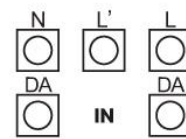
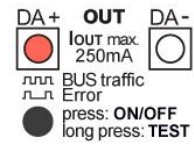

connection terminals  
DALI-2 Expander HS  
89452937-HS

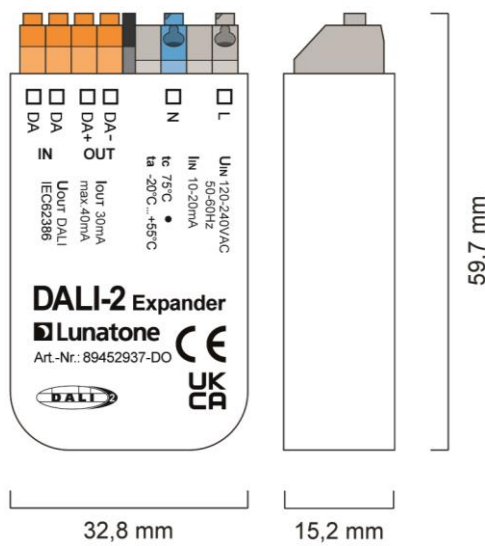

dimensions DALI-2 Expander DO  
Art.Nr.: 89452937-DO

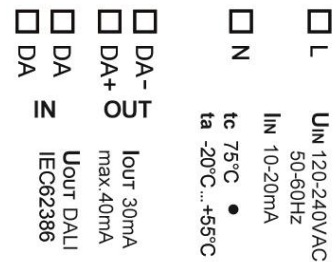

connection terminals  
DALI-2 Expander DO  
89452937-DO

## Installation

- The DALI-2 Expander is intended for remote installation in the ceiling or in an enclosure, ensure proper cable relief for installation in protection class II devices.
- The DALI-2 Expander HS is suited for DIN rail mounting, ensure protection against electric shock by an appropriate enclosure.
- The DALI-2 Expander DO is intended for back box installation or for integration in protection class II devices. For installation in protection class II devices proper cable relief needs to be ensured.
- The wiring should be carried out as a permanent installation in a dry and clean environment.
- Installation may only be carried out in a voltage-free state of the system and by qualified specialists.
- National regulations for setting up electrical systems must be followed.
- Connect power supply terminals L and N to mains voltage according to the labelling.
- The polarity of the output voltage is marked on the housing (DA+, DA-).
- The DALI line may be routed together with the mains voltage (in one cable or as single wires in a tube)
- The DALI-line must **not** be connected to the mains or extra low voltage systems.
- Only 1 wire may be connected to each terminal. When using double wire end ferrules, the connection capacity of the terminal must be considered.

- The DALI wiring can be realised with standard low-voltage installation material. No special cables are required.
- Wiring topology of the DALI-line: Line, Tree, Star.
- Wiring check and pressing the test button on the latest Version of the DALI-2 Expander

**short press:** recalls MAX broadcast, DALI-2 Expander's LED flashes.

Another short press sends broadcast OFF, the LED on the DALI-2 Expander turns on<sup>1</sup> and indicates bus traffic (normal operation).

**long press:** all luminaires connected to the DALI system will be controlled by a test sequence (on, off, dimming). The LED on the DALI-2 Expander flashes as long as the test sequence is active. The test sequence can be stopped with a short press of the test button. The test mode is automatically stopped when a DALI command is received on the DALI bus input side. (periodic repetitions (see section "Command repetition" page 9) are deactivated while the test mode is active) With ending the test mode the LED on the DALI-2 Expander goes back to normal operation (= on<sup>1</sup> and shortly flashing on bus traffic).



**Attention:** The DALI-signal is not classified as SELV circuit (Safety Extra Low Voltage). Therefore, the installation regulations for low voltage apply.



The voltage drop on the DALI line must not exceed 2V at maximum length (300m) and maximum bus load (250mA).



**Attention:** an unsuitable DALI power supply can cause damage of the DALI devices!

<sup>1</sup> for current version, previous versions LED normal operation: LED **off** and short flashing during bus traffic.

Do not use standard DC power supplies on the DALI-line, since they do not

meet the requirements for DALI communication.

### Application Example

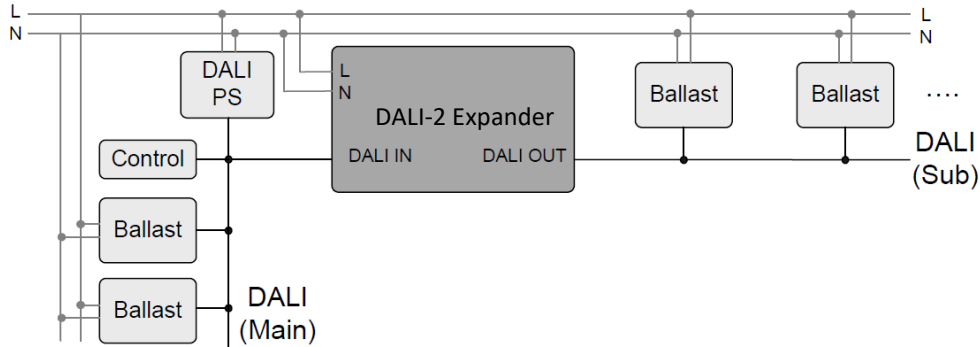

Expansion of a DALI line (Main) with a DALI subordinate line (all control commands sent to the DALI-2 Expander are sent Broadcast to the DALI sub-line.)

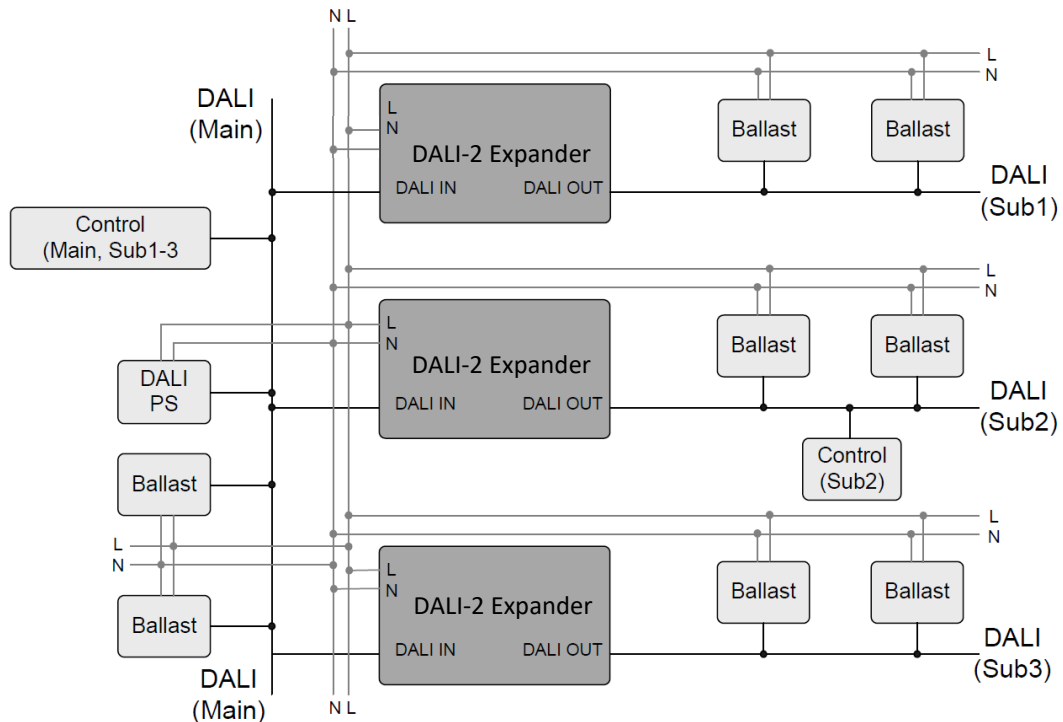

Expansion of a DALI line (Main) with multiple broadcast controllable DALI sub-lines. The additional control module in DALI (Sub2) enables the specific control of the sub-line.

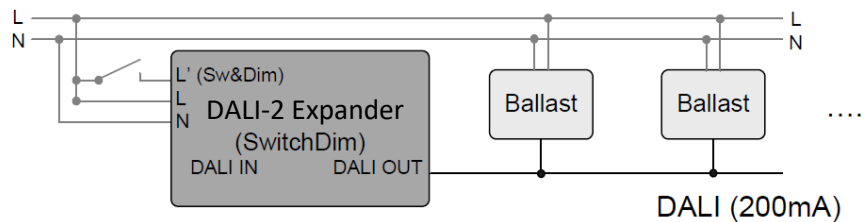

Control of DALI-ballasts via Switch-Dim (DALI-2 Expander DES, DALI-2 Expander HS)

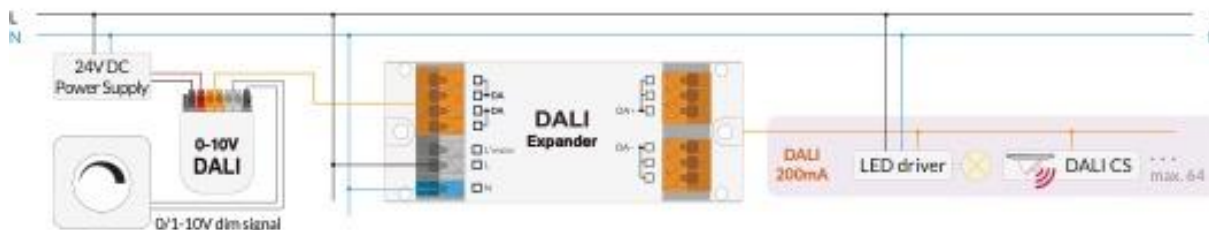

Control of 64 DAL luminaries with a 0-10V control device and a 0-10V to DALI converter (Art.Nr: 86458352)

## Addressing and Configuration

- after installation the DALI-2 Expander is ready for operation
- It must be ensured that the maximum current consumption of the DALI devices on the output side does not exceed the guaranteed output current (200mA) of the DALI Expander
- The SwitchDim input and DALI-Broadcast commands can be used to control the device immediately (maximum cable lengths for SwitchDim: 10-15m (depending on the version and interference fields)).
- The DALI-2 Expander can be addressed with the DALI Cockpit PC Software. When using the [DALI Cockpit Software](#), the PC must be connected to the DALI bus via a suitable interface module ([DALI-2 USB](#); [DALI USB](#), [DALI-2 WLAN](#), [DALI-2 Display](#), [DALI-2 IoT](#), [DALI 4Net](#), [DALI SCI RS232](#)). The DALI Expander is automatically recognised by the DALI Cockpit during the addressing process and listed in the device overview.
- Scene values, groups and other DALI settings of the devices at the output sub-line can be configured in the DALI Cockpit via the DALI-2 Expander device page (both DALI and DALI-2 gears are supported). Also, settings of the DALI-2 Expander itself are available, see section “Function”.
- Status-LED:
  - On, briefly lighting up during bus traffic/activity: normal operation<sup>1</sup>
  - flashing 50% on: test-mode active
  - flashing 90% on: error (e.g. bus short, no bus supply) on output and/or input side

## Function

With the DALI-2 Expander the number of DALI control gears can be extended. On the input side (main DALI Line) the DALI-2 Expander represents one device (one DALI address). All commands received by the device are forwarded broadcast to the sub-line (DALI OUT). Hence control gear connected to DALI OUT can be controlled via the one DALI address of the DALI-2 Expander. The power supply for the DALI sub-line is provided by the Expander (200mA). For command forwarding there are no device type specific restrictions. DALI-2 commands such as “Go to Last Active Level” are also supported.

The test button can be used to start and stop a test sequence for testing the DALI sub-line.



**DALI Parameters**

The DALI parameters: scenes, min level, max level etc. can be defined on the device page of the DALI-2 Expander. By saving, the DALI settings are broadcast to all devices at the output. Without saving, the DALI Expander does not overwrite the dimmer settings. During operation, commands are forwarded; with the settings in the dimmers defining the output.

**Periodic Sending of Device Settings**

With the option “periodic sending of device settings”, the DALI device settings entered (scenes, min. level, max. level, power-on level, system failure level, fade time, fade rate) are transmitted periodically (10 minutes) to the DALI output side. Therefore, devices on the DALI output side can be easily replaced (As delivery default the feature is not enabled)

**Behaviour on System Failure on input side**

The behaviour on the DALI output side (secondary) in case of a system failure on the input side (primary) can be configured.

Following options are available:

- output side also bus power off
- output side bus power off for 650 msec
- output side bus power remains on
- send RECALL MAX (after 600 msec)
- send RECALL MIN (after 600 msec)
- send configured system failure level DAP (after 600 msec)

If SwitchDim operation is detected, the bus supply is always switched on.

**Command repetition**

The last sent light level command (DAP) can be repeated on the output side with a defined period. This feature ensures that after a phase failure and voltage recovery the luminaires return to the desired light level and do not remain at the power-on level.



**Assigned DALI Group**

Commands to assigned DALI groups on the input side are forwarded to the output side.

**Group Command forwarding**

With the option “group command forwarding”, group commands are forwarded (tunneled through) to the DALI output side. If the DALI Expander itself is in a group, commands to this group keep being broadcasted on the DALI output side. (As delivery default the feature is not enabled)

**Ignore Broadcast commands**

It can be set that the DALI Expander does not listen to or forward broadcast commands. If enabled the DALI-2 Expander will only forward commands that are sent to his own address or assigned group.

**DALI device type**

It can be set with which DALI device type the Expander answers to the DALI query “QUERY DEVICE TYPE”.

Queries – query lamp failure

A LAMP FAILURE of the DALI sub-line can be queried. Because of the strict DALI-Timing the answer from the DALI sub-line is not received in time - to get a valid response, the query must be sent twice in a row.

DALI commands:

Query	Answer on Lamp Failure
Query Actual Level	255
Query Status	Bit [1] =1
Query Lamp Failure	YES



Actual Level: 100%

ON (MAX) OFF  
MIN

Set Act Level  
0 %  
Set

**Device Info**

Name: DALI-2 Expander HS    Article Number: 89452937-HS    GTIN: 9010342014024  
 Manufacturer: Lunatone    Serial Number: 10501    FW: 1.0.26  
 Device Type:    Type: Control Gear  
 DALI Ver: V2.0    Short Address: (A0) DALI-2 Expander HS    Set

**Device Parameters**

**Groups**

0 1 2 3 4 5 6 7 8 9 10 11 12 13 14 15

**DALI Parameter**

MIN Level: 0.1 %  
 MAX Level: 100 %  
 Power On Level: MASK %  
 Fade time: 1.0 s  
 Ext Fade Time: fastest  
 Fade rate: 89.4 step/s

**Scenes**

0 MASK %    4 MASK %    8 MASK %    12 MASK %  
 1 MASK %    5 MASK %    9 MASK %    13 MASK %  
 2 MASK %    6 MASK %    10 MASK %    14 MASK %  
 3 MASK %    7 MASK %    11 MASK %    15 MASK %

Ignore Broadcast Config and Arc commands *i*  
 Ignore Broadcast commanc

Last DAP command repetition *i*  
 Enable  
 Period: \_\_\_\_\_ s

DALI Device Type *i*  
 No Device type

Primary Fail Mode  
 Turn Off

Enable Single Master ping  
 Enable group command forwarding *i*  
 Enable periodic sending of device settings *i*

Figure 1 DALI Cockpit Configuration

## Factory Default Settings

DALI groups	None
Min Level	0.1%
Max Level	100%
Power On Level	MASK
Fade time	1s
Fade rate	89.4 steps/s
scenes 0-15	inaktiv (MASK)
Ignore broadcast	disabled
Repeat last light level	Disabled
DALI device type selection	none
behavior on system failure input side	output side also bus power off
group forwarding	disabled
Repeat configuration	disabled

### DALI-2

The DALI-2 Expander (art.nr.: 89452937-\_) are the same as the previous DALI Expanders with FW>1.9. (art.nr.: 89453847-\_) in terms of connection and functionality. The devices only differ in the DALI-2 certification of the expander output side.

### Purchase Information

**Art.Nr. 89452937-DO:** DALI-2 Expander with integrated bus power supply for backbox installation

**Art.Nr. 89452937-DES:** DALI-2 Expander with integrated bus power supply for remote ceiling in narrow housing for luminaires or rail installation

**Art.Nr. 89452937-HS:** DALI-2 Expander with integrated bus power supply for DIN rail installation

### Additional Information and Equipment

Lunatone datasheets, manuals and software  
<http://www.lunatone.com/en/downloads-a-z/>

Lunatone DALI products  
<http://www.lunatone.com/en>

DALI-Cockpit – free configuration tool from Lunatone for DALI systems  
<https://www.lunatone.com/en/product/dali-cockpit/>

### Contact

Technical Support: [support@lunatone.com](mailto:support@lunatone.com)

Requests: [sales@lunatone.com](mailto:sales@lunatone.com)

[www.lunatone.com](http://www.lunatone.com)

### Disclaimer

Subject to change. Information provided without guarantee. The datasheet refers to the current delivery.

The function in installations with other devices must be tested for compatibility in advance.

