



DALI-2 4Ch PD

Datasheet

Phase Dimmer Module

4-channel phase dimmer with
DALI control input (DT4)

Art.Nr. 86451975-HS



DALI-2 4Ch PD Phase Dimmer Module

Overview

- 4 channel phase dimmer suitable for 4x 10W loads.
- suitable for dimming 230V LED retrofit lamps via DALI (Device Type 4)
- conversion of the DALI dimming level into a voltage, phase control configurable
- minimum dimming level (MIN LEVEL) can be set via DALI
- additional operating mode as switch (DT7 compliant)
- each channel has its own DALI address
- Simple configuration via DALI-Cockpit software tool and a Lunatone DALI interface (e.g.: [DALI-2 USB](#); [DALI USB](#), [DALI-2 WLAN](#), [DALI-2 Display](#), [DALI-2 IoT](#), [DALI 4Net](#), [DALI SCI RS232](#))
- DIN rail module (1DU)
- Maximum output current per channel 60mA



Specification, Characteristics

type	DALI-2 4Ch PD
article number	86451975-HS
input: L, N	
input type	mains
marking terminals	L, N
input voltage range	230V
input voltage frequency	50-60 Hz
max. control power	4x 10W
input: DA, DA	
input type	DALI control input
marking terminals	DA, DA
input voltage range	9,5V ... 22,5V
max. current consumption DALI	4mA
number of DALI addresses	4
output: LS1, LS2, LS3, LS4	
output type	trailing/leading edge phase cut of mains
marking terminals	LS1, LS2, LS3, LS4, N
output voltage range	0 to 230VAC
phase cut angle	0°-180°

output voltage frequency	like input L,N
max. output current	0.06A Eff ac / Kanal
load range	10W / Kanal
max. length between device and luminaire	50m

Insulation data

impulse voltage category	II
pollution degree	2
rated insulation voltage	250V
insulation DALI (DA,DA) / (L/N/LS1, LS2, LS3, L\$)	reinforced isolation
insulation test voltage	3000Vac

environmental conditions

storing and transportation temperature	-20°C ... +75°C
operational ambient temperature	-10°C ... +45°C
Rel. humidity, none condensing	15% ... 90%

general data

dimensions (l x w x h)	98 x 18 x 56mm
mounting	DIN rail, built-in, integration in protection class II devices
rated max. temperature tc	60°C
expected life time @tc	100.000 h (45°C)
protection class	II in intended use
protection degree housing	IP40
protection degree terminals	IP20

terminals

connection type	screw terminal
wire size solid core	0,5 ... 2,5 mm ² (AWG20 ... AWG14)
wire size fine wired	0,5 ... 2,5 mm ² (AWG20 ... AWG14)
wire size using wire end ferrule	0,25 ... 1,5 mm ²
stripping length	7 mm / 0,27 inch
locking torque	0,5Nm
actuation type	screw

standards

DALI	EN 62386-101, EN62386-102, EN62386-205
EMV	EN 61547 EN 50015 / IEC CISPR15
safety	EN 61347-2-11 EN 61347-1
markings	DALI-2, CE, UKCA

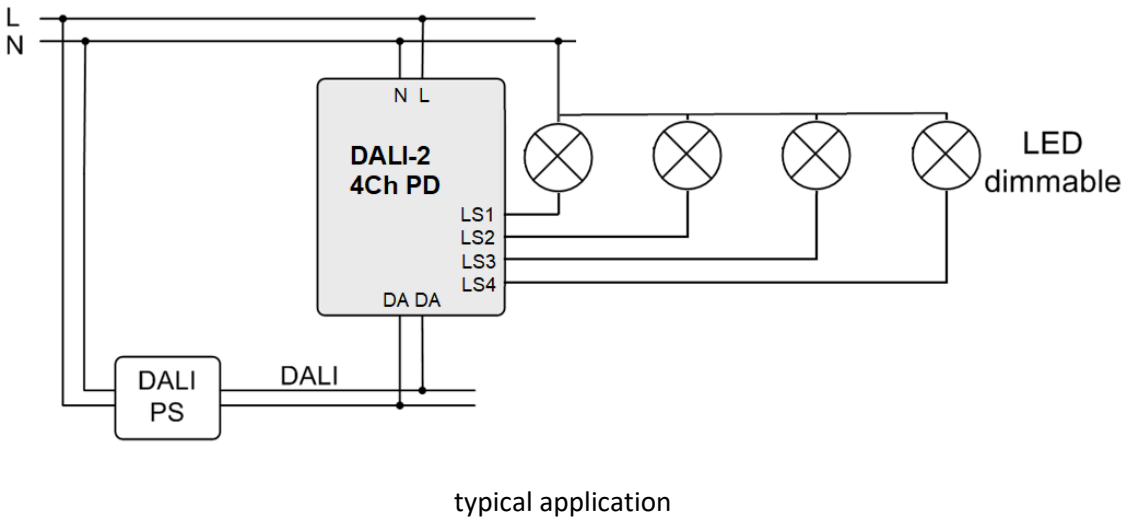
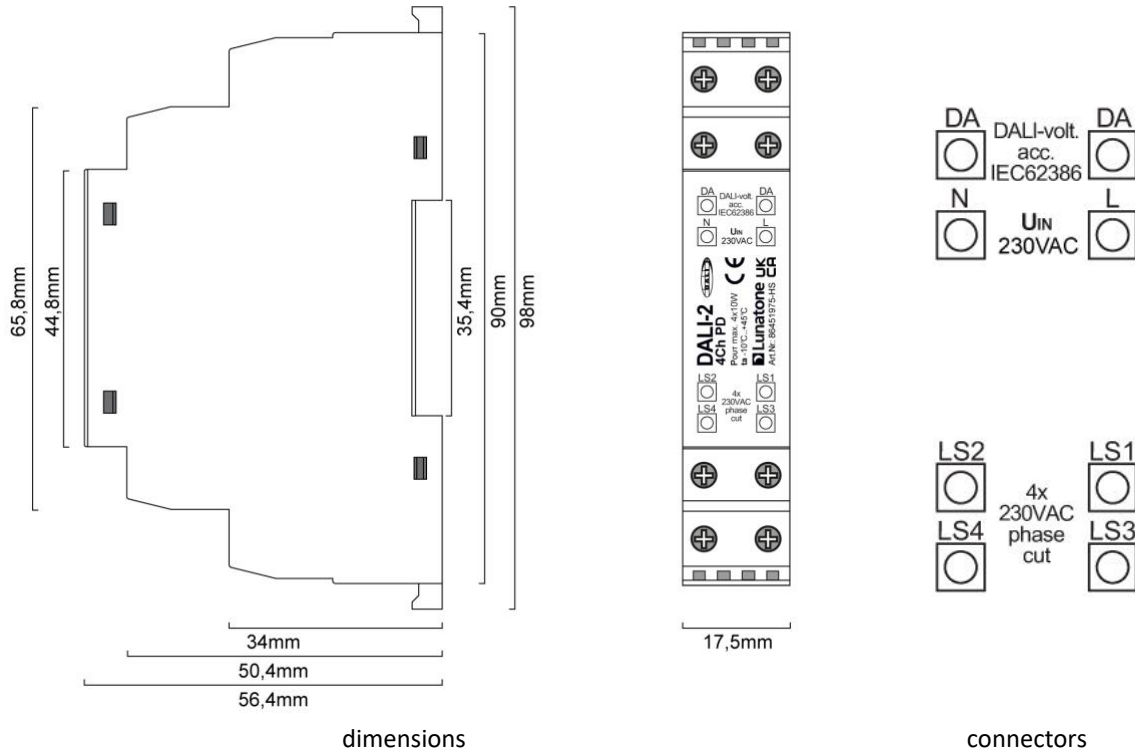

Factory Default Settings

	Factory default	DALI Standard
operating mode	DT4	--
Min Level	3%	3%
Max Level	100%	100%
Power On Level	MASK (keep current value)	100%
Fade Time	1s	none
Fade Rate	89.4 steps/s	44.7 steps/s
System Failure Level	100%	100%

Scene values:	Scene	Ch1	Ch2	Ch3	Ch4	no scene values (all scenes = MASK)
	0	100%	0%	0%	0%	
	1	0%	100%	0%	0%	
	2	0%	0%	100%	0%	
	3	0%	0%	0%	100%	
	4	0%	0%	100%	100%	
	5	0%	100%	0%	100%	
	6	100%	0%	0%	100%	
	7	100%	0%	100%	0%	
	8	100%	100%	0%	0%	
	9	0%	100%	100%	0%	
	10	100%	0%	100%	100%	
	11	100%	100%	0%	100%	
	12	100%	100%	100%	0%	
	13	0%	100%	100%	100%	
	14	100%	100%	100%	100%	
15	0%	0%	0%	0%		
Ignore broadcast commands	disabled					--
Behaviour at DALI RESET command	set DALI Standard values, see column 2					--

Installation

- The DALI-2 4Ch PD is suitable for DIN rail mounting, protection against shock has to be provided by an appropriate enclosure.
- The wiring should be carried out as a permanent installation in a dry and clean environment.
- Installation may only be carried out in a voltage-free state of the system and by qualified specialists. The system must also be switched off when replacing the luminaire.
- National regulations for setting up electrical systems must be followed.
- Connect power supply terminals L and N to mains voltage according to the labelling.
- Connect terminals LS1, LS2, LS3, LS4 and N to the load. Ensure that the wiring length to the load does not exceed 50m.
- Only connect luminaires that are in the rated power range of the dimmer and are suitable with respect to the load type.

Also consider the power factor of the luminaires.



Attention: the intended use of the DALI-2 4Ch PD is dimming of LED-retrofit-luminaires, do not use with halogen lamps or magnetic transformers

- the connection to the DALI-line (DA, DA) is polarity free.
- The DALI line may be routed together with the mains voltage (in one cable or as single wires in a tube)
- The DALI-line must not be connected to the mains or extra low voltage systems.
- The DALI wiring can be realised with standard low-voltage installation material. No special cables are required.
- Wiring topology of the DALI-line: Line, Tree, Star



Attention: The DALI-signal is not classified as SELV circuit (Safety Extra Low Voltage). Therefore, the installation regulations for low voltage apply



The voltage drop on the DALI line must not exceed 2V at maximum length (300m) and maximum bus load (250mA).

Commissioning

- After installation the DALI-2 4Ch PD is ready for use
- The DALI-2 4Ch PD can be addressed with the DALI Cockpit PC Software. When using the [DALI Cockpit Software](#), the PC must be connected to the DALI bus via a suitable interface module ([DALI-2 USB](#); [DALI USB](#), [DALI-2 WLAN](#), [DALI-2 Display](#), [DALI-2 IoT](#), [DALI 4Net](#), [DALI SCI RS232](#)). The DALI-2 4Ch PD is automatically recognised by the DALI Cockpit during the addressing process and listed in the device overview.
- Scene values, groups, DALI parameters and device specific settings can be configured in the DALI Cockpit, see section Function below.

Function

Operating Mode DT4

The DALI-2 4Ch PD, as an interface between classic dimming technology (phase dimming) and DALI, is based on the standard for DALI Control Gears (IEC 62386-102) and device type 4 devices (IEC 62386-205).

The DALI PD interface converts the DALI dim level into a voltage signal.

The phase dimmer can operate as trailing edge or leading edge dimmer, depending on the load.

The operation mode (trailing/leading edge) can be queried via DALI (DT4). The dimming curve follows a logarithmic characteristic corresponding to DALI. The phase cut control generates a sinusoidal voltage with leading/trailing edge phase cut. The PHYSICAL MINLEVEL is 3%.

Operating Mode DT7

Der DALI-2 4Ch PD supports an additional operating mode. Instead of phase dimming (DT4) the device can act as switch (DT7).

The behaviour in this operating mode corresponds to DALI specification for device type 7 (IEC 62386-208)

The switching characteristic is determined by the comparison of the virtual direct arc power level (VDAP) with 4 thresholds.

The virtual dim level (VDAP) is like the dim level of DALI-ballasts and is therefore limited by MINLEVEL and MAXLEVEL and influenced by fade-time and fade-rate.

For each dim direction 2 thresholds can be defined. They are compared with the virtual dim level and as a result the output is switched on or off:

virtual dim direction	comparison of virtual dim level and thresholds	output
UP	VDAP >= UP SwitchOn threshold	ON
UP	VDAP >= UP SwitchOff threshold	OFF
DOWN	VDAP <= DOWN SwitchOn threshold	ON
DOWN	VDAP <= DOWN SwitchOff threshold	OFF

If a threshold value is set to “MASK” the threshold is inactive and does not influence the relay output.

Some examples of switching characteristics are shown in the following Figure 1. With the help of the fade time switch on and switch off delays can be realized. Configuration of the switching thresholds in the DALI Cockpit see also Figure 4.

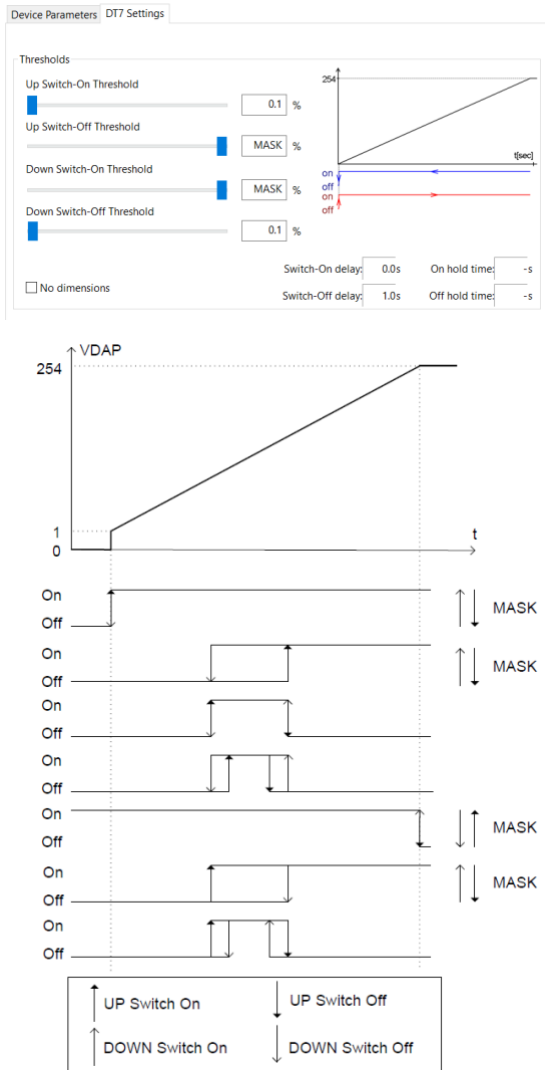
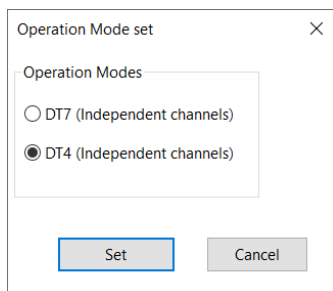

Figure 1 possible switching characteristics

Operating Mode Selection

On the device overview page, section “set Operating mode” select between DT4 and DT7:



Selection: leading edge, trailing edge

In the operating mode DT4, it is possible to choose between leading edge or trailing edge mode – section “change Edge Mode”:

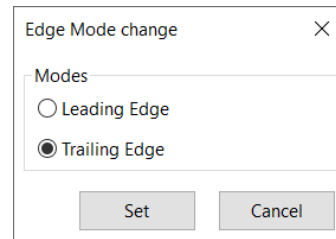

Ignore Broadcast commands

The “Ignore Broadcast” setting can be used to ensure that the phase dimmer does not respond to broadcast commands on the DALI bus (group assignments are not ignored). The setting is possible in the devices overview page (see Figure 2)

Adjustable DALI RESET behaviour

The response to a DALI reset command is configurable. The following options are available:

- *Ignore command*: the DALI reset command does not trigger any changes to the device settings
- *DALI standard*: the selected device settings are reset to the values defined in the DALI standard (see table 1 below - second column: DALI standard values)
- *Custom settings*: the current device settings can be saved. With a DALI Reset command, the selected parameters (6 check boxes) are then reset to these saved values.

Calibration – Light adjustment

it is possible to calibrate light sources, with the option: Calibration. The MIN level (default: 0.1%) an intermediate value (default: 33%) and the MAX level (default: 100%) can be adjusted and matched between light sources.

To do this, set the desired level with the upper slider. Apply the value and start the fine adjustment by pressing the button next to it. The appropriate fine adjustments can now be made with the calibration slider below, see also Figure 3

Device Channel Settings

Channel specific settings such as scenes, min level, max level, power on level, system failure level,... can be made for each channel on the respective page in the DALI Cockpit.

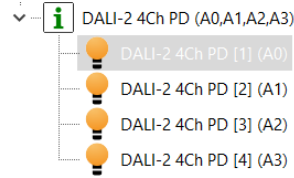

See also Figure 4 page 9

DALI Cockpit Configuration – Operating Mode DT4

Selection operating mode

- DT4
- DT7

With selection DT7 the DT7 settings become available in a second tab

Light calibration see Figure 3 and section „Calibration – Light adjustment“

Figure 2 DALI Cockpit settings – overview page

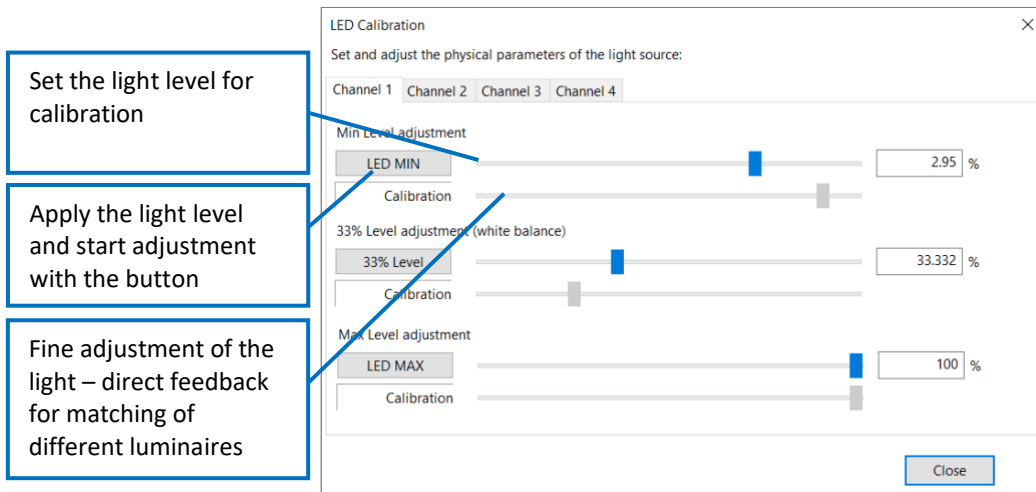

Figure 3 Calibration - light adjustment settings

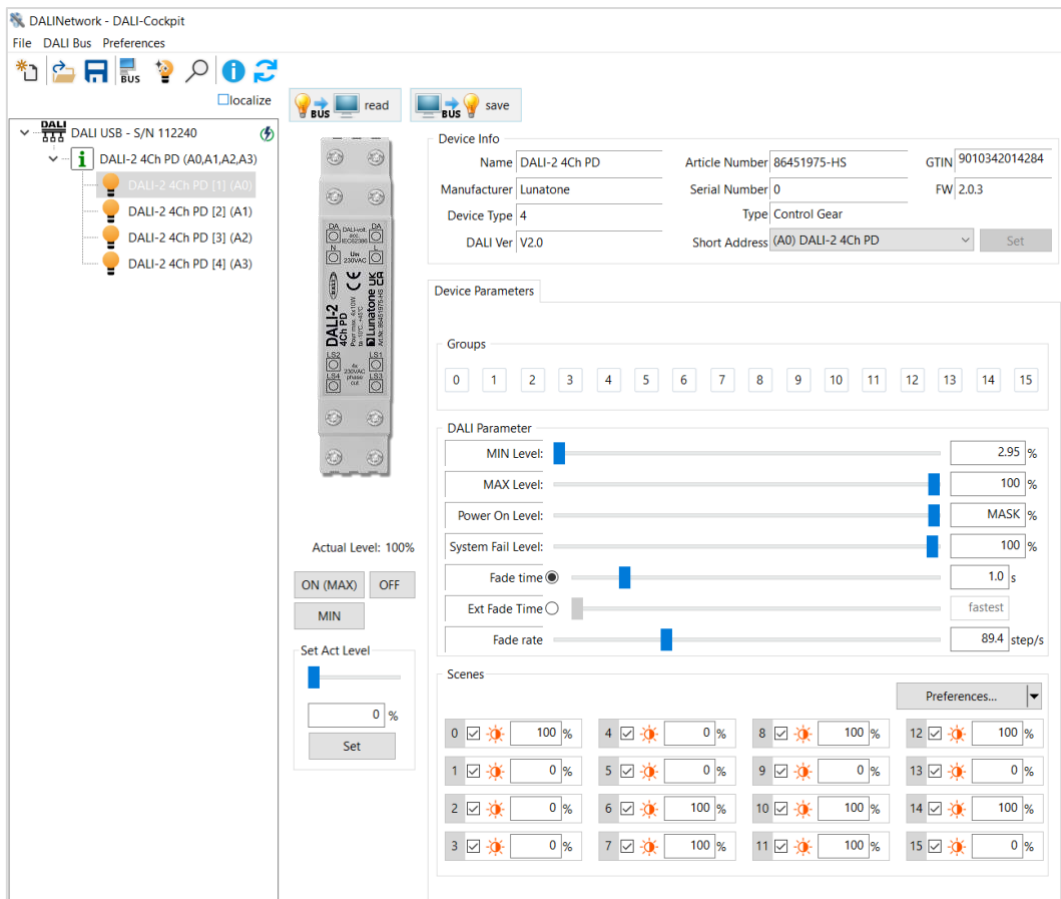

Figure 4 DALI Cockpit – device settings channel 1

Purchase Oder Information

Art. Nr. 86451975-HS: DALI-2 4Ch PD, 4-channel phase dimmer, 4 DALI addresses, DIN rail

Additional Information and Equipment

DALI-Cockpit – free configuration tool for DALI systems

www.lunatone.com/en/product/dali-cockpit/

Lunatone DALI products

<https://www.lunatone.com/en/>

Lunatone datasheets and manuals

<https://www.lunatone.com/en/downloads-a-z/>

Contact

Technical Support: support@lunatone.com

Requests: sales@lunatone.com

www.lunatone.com



Disclaimer

Subject to change. Information provided without guarantee. The datasheet refers to the current delivery.

The compatibility with other devices must be tested in advance to the installation.