

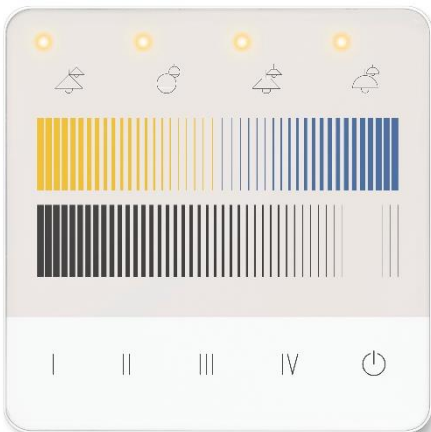

DALI-2 Touchpanel 04

Datasheet

Multi Control Module



Multifunctional
DALI-2 control module
with flexible
button layout

Art.Nr. 24035290-G__

Various DALI-2 Touchpanel Layouts:

Art. Nr.: G000 unprinted glasses

Art.Nr.: G10A (Dimming, 4 Scenes, 4 Groups)

Art. Nr.: G11A (Dimming, 4 Scenes, Tunable White, 4 Groups)

Art. Nr.: G12A (Dimming, 4 Scenes, Tunable White, 4 Target selection Buttons)

Art. Nr.: G13A (Dimming, 4 Scenes, Colour RGB, 4 Groups)

Art. Nr.: G14A (Dimming, 4 Scenes, Colour RGB, 4 Target selection Buttons)

Overview:

https://www.lunatone.com/wp-content/uploads/2020/11/DALI-2-Touchpanel-Layouts_EN.pdf

DAI-2 Touchpanel 04 Multifunctional Control Module

Overview

- multifunctional control module for DALI and DALI-2 systems
- multi-master capable: Several modules can be installed within a DALI circuit and / or a DALI group.
- capacitive touch interface
- up to 16 configurable keys
- 4 led lights configurable as indicators for selected groups or scenes
- Palm detection for fast control
- standard layouts and factory settings for easy installation without configuration
- flexible layout - individual design - layout exchange on site. Additional glass inserts with different prints available as accessories.
- easy configuration via Lunatone DALI USB interface and DALI-Cockpit Software Tool
- touch interface material: glass
- plastic frame (RAL 9016) aluminium frame and customer-specific frame colours upon request
- integrated DALI-2 application controller
- application controller: direct control of DALI devices
- in addition to the standard DALI commands, the application controller also supports DALI DT8 TC and RGB (W) control as well as macros
- Instance-mode: Easy integration through 16 DALI-2 pushbutton instances and 5 DALI-2 analogue instances (slider)
- easy installation on a flush-mounted installation box
- the module is supplied by the DALI bus – no additional power supply necessary
- version with integrated DALI power supply available (“-PS”)
- equivalent version without LED lights: [DALI-2 Touchpanel 03](#)
- DALI-2 control unit according to IEC62386-103



Specification, Characteristics

Type	DALI-2 Touchpanel
article number	24035290
GTIN	9010342013089
DALI-Interface, power supply: DA, DA	
output type	DALI, DALI-2, Multimaster

terminal markings	DA, DA
voltage range	9,5V ... 22,5Vdc according to IEC62386
typical current consumption DALI (16,5V)	2 mA
DALI addresses	0
DALI-2 addresses	1

Insulation data:

impulse voltage category	II
pollution degree	2
rated insulation voltage	250V
insulation DALI / mains	reinforced isolation
insulation test voltage DALI / mains	3000Vac

environmental conditions:

storing and transportation temperature	-20°C ... +75°C
operational ambient temperature	-20°C ... +45°C
rel. humidity, not condensing	15% ... 90%

general data:

dimensions (l x w x h)	87,7mm x 87,7mm x 16,5mm
mounting	back box installation
material	touch-interface: glass, frame: plastic
expected life time	100.000h
Protection class	II (when used/installed as intended)
protection degree housing	IP40
protection degree terminals	IP20
Operating modes	Application Controller, DALI-2 Instance mode

terminals:

connection type	spring terminal connectors
wire size: solid core	0,5 ... 1,5 mm ² (AWG20 ... AWG16)
wire size: fine wired	0,5 ... 1,5 mm ² (AWG20 ...AWG16)
wire size: using wire end ferrule	0,25 ... 1 mm ²
stripping length	8,5 ... 9,5 mm / 0,33 ... 0,37 inch
tightening/ release of wire	push mechanism

standards:

DALI	IEC62386-101:2014 IEC62386-103:2014
EMV	EN 61547 EN 50015 / IEC CISPR15
safety	EN 61347-2-11 EN 61347-1
Markings	DALI-2, CE, UKCA, RCM

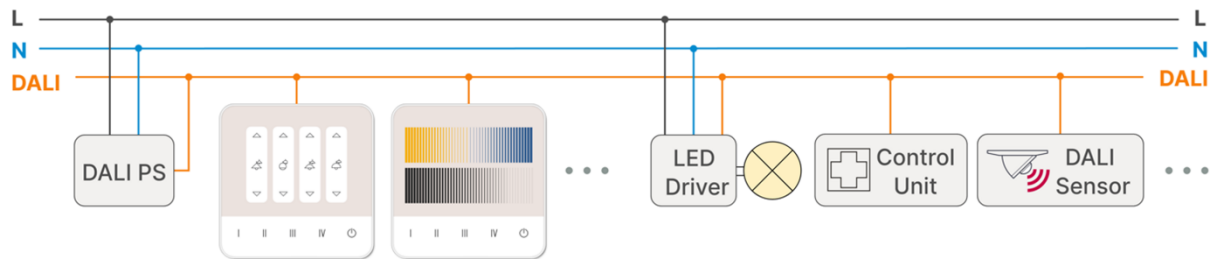
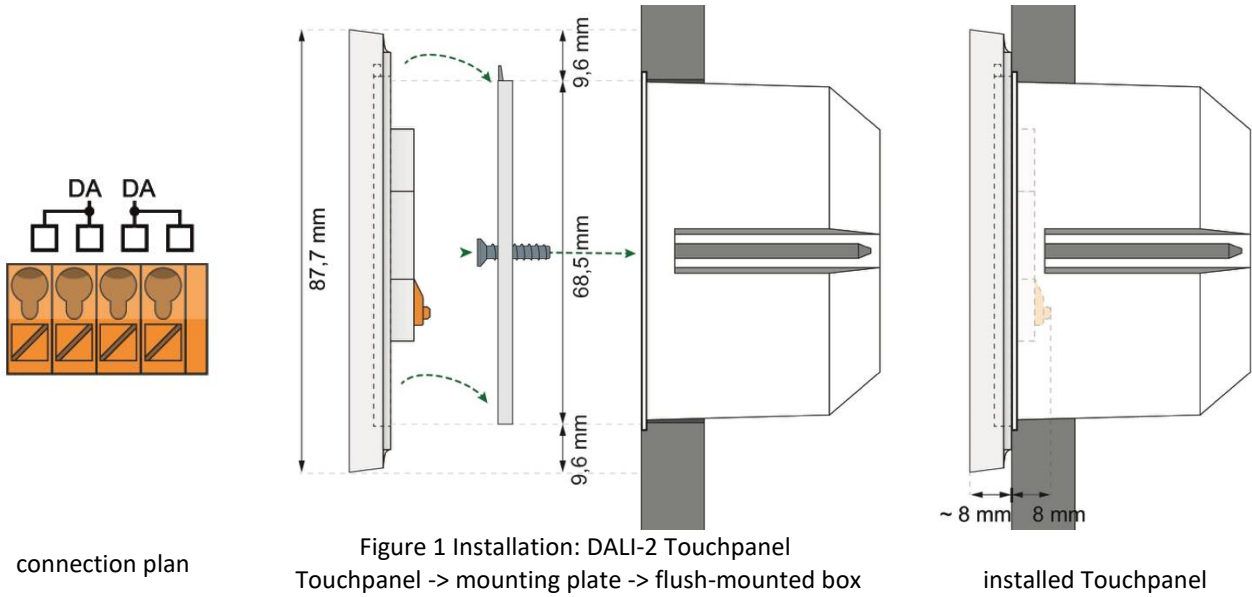
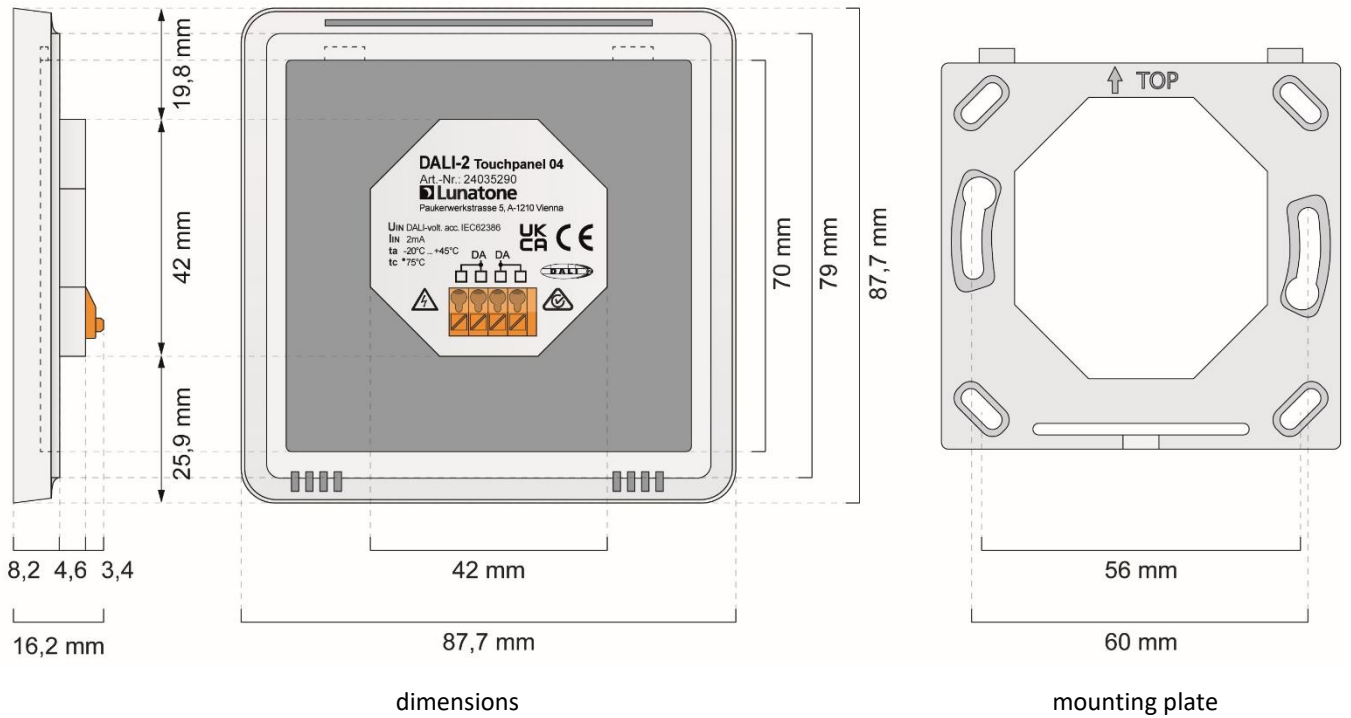
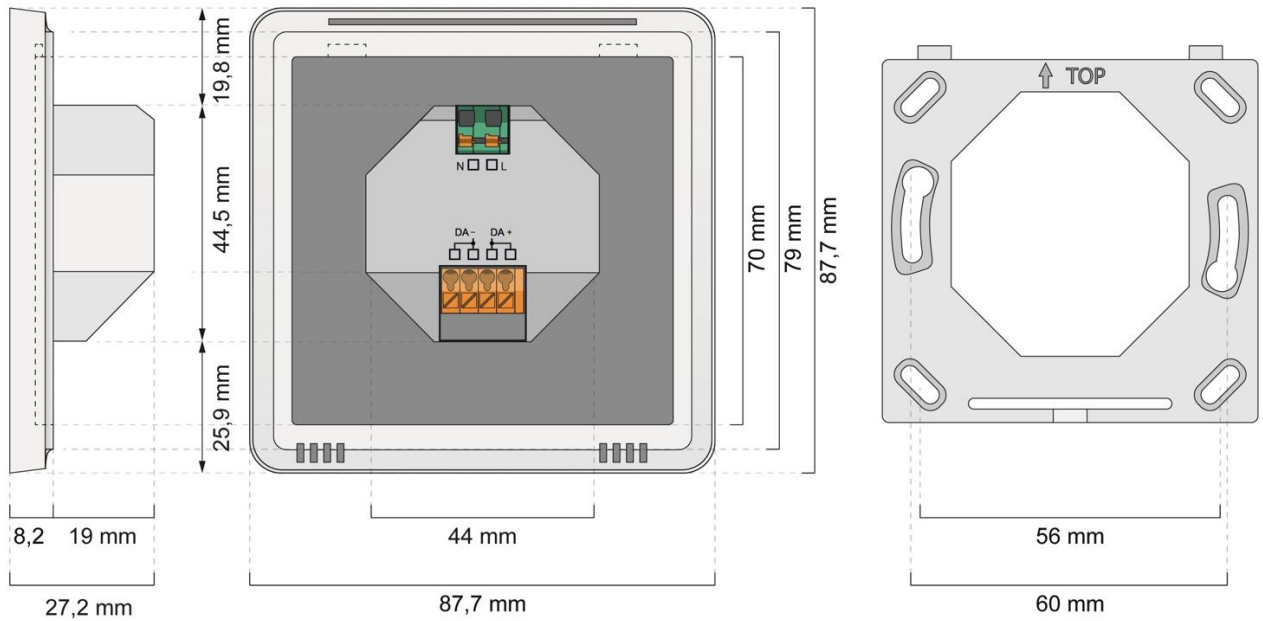

Figure 2 DALI-2 Touchpanel typical application

Specification, Characteristics – DALI-2 Touchpanel PS: Version with integrated Bus Power Supply

Version with integrated bus power supply (70mA). If not stated otherwise in the table below all information for standard version applies – all DALI-2 Touchpanel versions are available with integrated power supply 70mA.

type	DALI-2 Touchpanel-PS
article number	24035290-PS
input L,N	
input type	supply, mains-voltage
markings	N, L
input voltage range	230V AC
max. input supply current	17 mA
Input supply frequency	50Hz / 60Hz
power consumption max.	2W
start-up time	<250ms
output DA+, DA-	
output type	DALI
markings	DA-, DA+
output voltage range	12Vdc.... 20,5 Vdc
guaranteed DALI supply current	70mA
max. DALI supply current	80mA
Open circuit proof	yes
Short circuit proof	yes
insulation data	
Impulse voltage category	II
Pollution degree	2
Rated insulation voltage	250V
Rated impulse withstanding voltage	4 kV
Insulation DALI / mains	reinforced isolation
Insulation test voltage DALI /mains	3000V a.c.
general data:	
dimensions	88mm x 88mm x 39mm



dimensions DALI-2 Touchpanel PS - Version with integrated DALI bus power supply

mounting plate

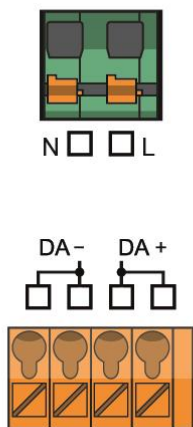

connection plan
DALI-2 Touchpanel PS

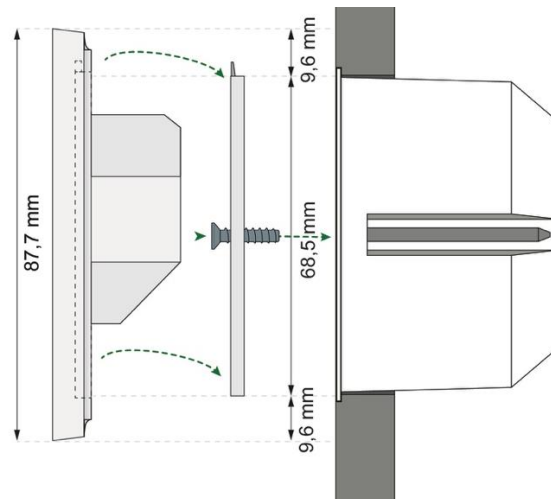
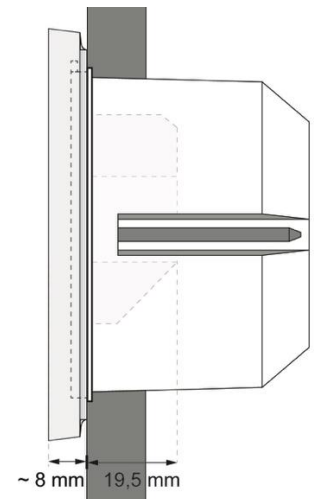
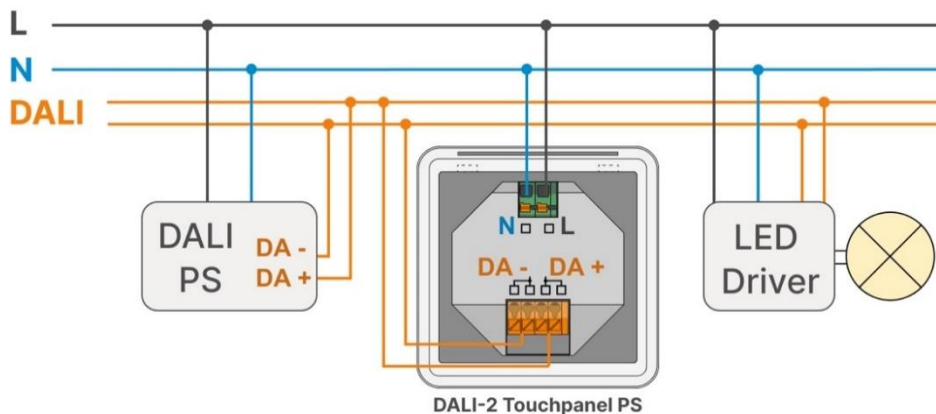

Figure 3 Installation DALI-2 Touchpanel PS
Touchpanel -> mounting plate -> flush-mounted box



installed Touchpanel



If **2 bus power supplies** are on the same DALI bus: connect with the same **polarity** (DA+, DA-)!

max total supply current on the bus: **250mA!**

Figure 4 installation example DALI-2 Touchpanel PS with an additional DALI PS on the DALI bus

Installation

- The DALI-2 Touchpanel is directly connected and supplied by the DALI bus. A DALI bus power supply (e.g., DALI PS) is required, no additional power supply is needed.
- **DALI-2 Touchpanel PS:** includes a DALI bus power supply (70mA). If 2 or more bus power supplies are connected on the same DALI bus, they need to be connected with the same polarity. (marked with DA+, DA-), see Figure 4, page 6.

 It is possible to connect multiple DALI PS on a DALI line, but **the sum of all maximum supply currents must not exceed 250 mA!**

- **DALI-2 Touchpanel** (and DALI-2 Touchpanel PS with no additional DALI PS): the connection to the DALI terminals can be made regardless of polarity. The bus input is protected against overvoltage (mains voltage).
- The wiring should be carried out as a permanent installation in a dry and clean environment.
- Installation may only be carried out in a voltage-free state of the system and by qualified specialists.
- National regulations for setting up electrical systems must be followed.
- The DALI wiring can be realized with standard low-voltage installation material. No special cables are required.
- Only 1 wire may be connected to each terminal. When using double wire end

ferrules, the connection capacity of the terminal must be considered.

 **Attention:** The DALI-signal is not classified as SELV circuit (Safety Extra Low Voltage). Therefore, the installation regulations for low voltage apply.

 The voltage drop on the DALI line must not exceed 2V at maximum length (300m) and maximum bus load (250mA).

Wall Mounting

The DALI-2 Touchpanel can be attached to an electrical socket using a mounting plate (included), see also Figure 1 on page 4 and Figure 3 on page 6

First the mounting plate is attached to the electrical socket, paying attention to the orientation - Marking:  **TOP**.

Then the DALI touch panel can be hooked in from the top and fixed with the screw on the bottom.

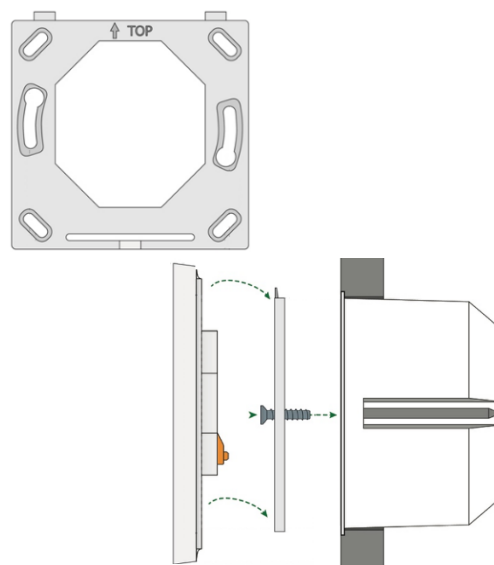

Addressing and Configuration

- After installation, the device can already be used with the default factory settings.
- Addressing and changes to the factory settings, such as setting the effective range and functions, are possible with the Software tool DALI Cockpit (Windows PC).
- When using the DALI-Cockpit Software, the PC must be connected to the DALI bus via a suitable interface module (DALI USB, DALI 4Net, DALI SCI RS232). The DALI-2 Touchpanel is automatically recognised by the DALI Cockpit during the addressing process and listed in the device overview.
- The addressing is done according to the DALI-2 specification and the device receives a corresponding address.
- For localisation a buzzer is integrated in each DALI-2 Touchpanel. Alternatively, the allocation can also be done via the serial number of the device.

Touch Panel Layout

The DALI-2 Touchpanel is equipped with an interchangeable glass with layout print as user interface.

An overview of the Lunatone standard layouts can be found in section “Standard Layouts and Factory Settings” on page 16.

The devices are delivered with the ordered layouts. Also, customer-specific designs can be realized. Design templates can be found at: <https://www.lunatone.com/en/produkt/dali-2-touchpanel/>.

The User Interface can be adapted to the respective needs using standard graphics software. On request, it is also possible to use a glass without print and paper inserts (size of the inserts: 86.4mm x 86.4mm).

Thanks to the interchangeable user interface, the touch panel offers customer-specific flexibility and can be adjusted to any application.

The exchange of the layout is carried out by pressing on the upper edge – pushing the frame down, away from the glass, see Figure 5.

Additional glasses are available as accessories. Both standard and custom designs can be ordered from Lunatone.



Attention: If the position of the buttons does not match after changing the layout, the configuration also needs to be adjusted (DALI Cockpit Software).

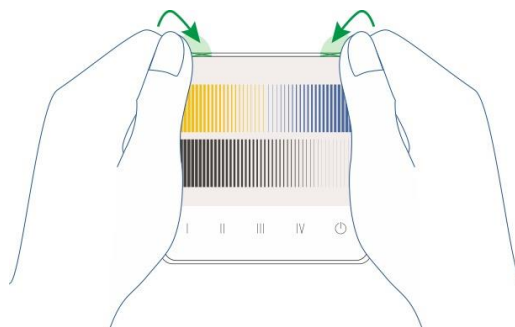

Figure 5 pressure points to exchange the glass

Operation and Function

The DALI-2 Touchpanel is a universal module to control DALI compatible luminaries.

Each DALI-2 Touchpanel layout can implement up to 16 buttons. The function of each button can be configured individually.

The DALI-2 Touchpanel 04 includes 4 backlight LED which can be configured to indicate the latest group, scene or the state of the effective-range selection function BF35. The configuration is described in detail in section LED light indicators on page 16.

On delivery the buttons are preconfigured, matching the inserted layout.

If the design is changed, the button configuration should be adapted accordingly.

As with other Lunatone control devices, the settings can be changed with the DALI Cockpit Software tool.

In the DALI Cockpit device overview existing configurations can be saved or loaded by right-clicking on the device, using "Export device settings ..." or "Import device settings ..." accordingly, see Figure 6.

All Lunatone standard layout configuration files and descriptions can be found under:

<https://www.lunatone.com/en/produkt/dali-2-touchpanel/>

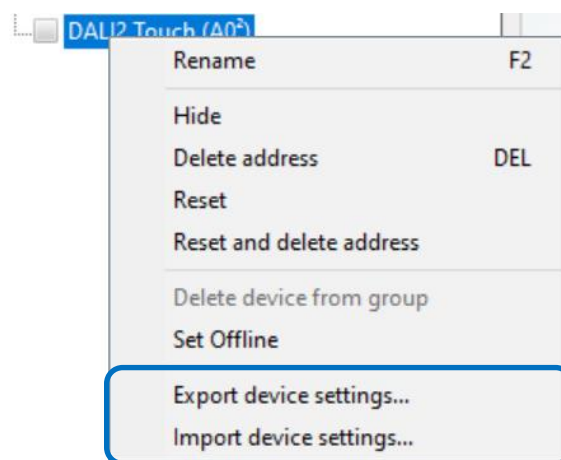

Figure 6 import or export device settings

With the DALI Cockpit Software tool, existing settings can be adjusted to fit the application e.g. number of buttons, button functions, effective range, etc. see Figure 7 and Figure 8.

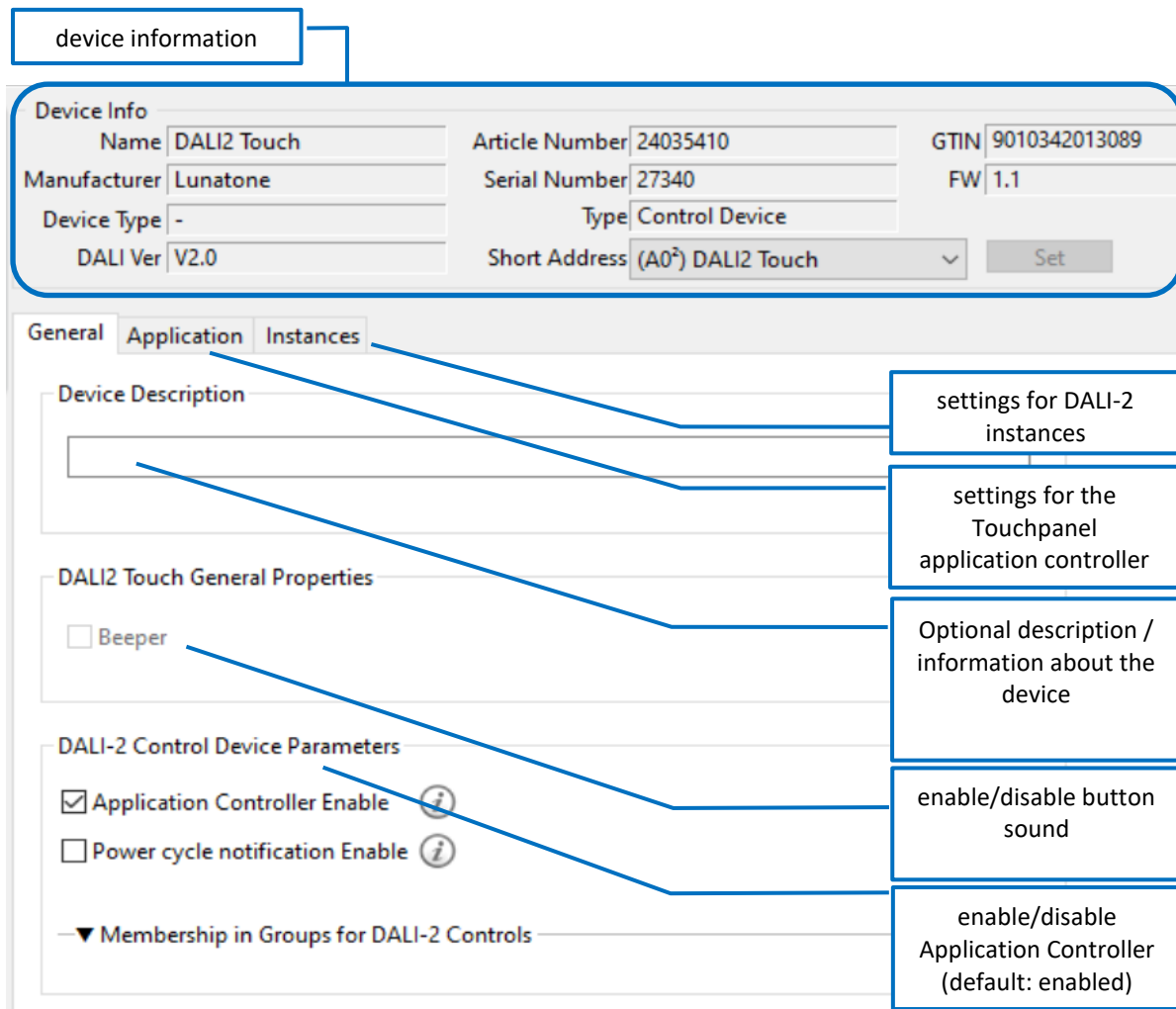

Figure 7 general settings – DALI Cockpit

It is necessary to distinguish between application controller and DALI-2 instances.

The application controller gives direct DALI control commands that are immediately executed by the DALI drivers.

The DALI-2 instances generate event messages that are interpreted and processed by higher-level control units (WAGO, Beckhoff, LUNATONE DALI-2 KNX gateway). General information on the DALI-2 instance mode:

<https://www.lunatone.com/en/dali-2-factsheet/> section: DALI-2 Instancemode

The application controller and instance event messages can be active at the same time.

Additional Information: A deactivated Application Controller is indicated in the DALI Cockpit device tree with: **A**.
A device with active instances is indicated with: **i**

Figure 8 Application: Application Controller

Button position

To adjust the button positions, a reference picture can be added to the preview on the top left corner of the Cockpit Window (Figure 8 "Add picture"). Supported image formats: bmp, jpg, png, gif, tif, tiff, emf.

The positions of the buttons are defined by 4 parameters:

- Button Centre X in % Button Width X in %
- Button Centre Y in % Button Height Y in %

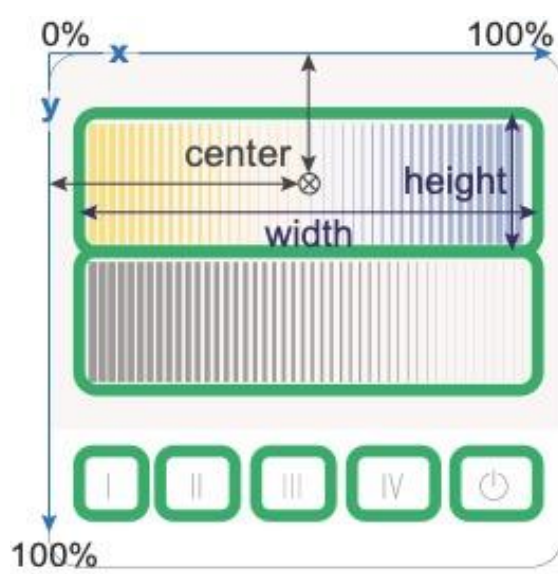

Figure 9 Button positions (indicated in green)

Destination address / effective range

In the section “destination addresses” it is possible to define which devices are affected by the button function. Possible destination addresses:

- Broadcast (an alle)
- DALI group (0 - 15)
- DALI single address (0 - 63)

Up to 4 different target addresses can be defined for each button. When the button is pressed the target addresses 1 to 4 will be processed sequentially (see Figure 10)

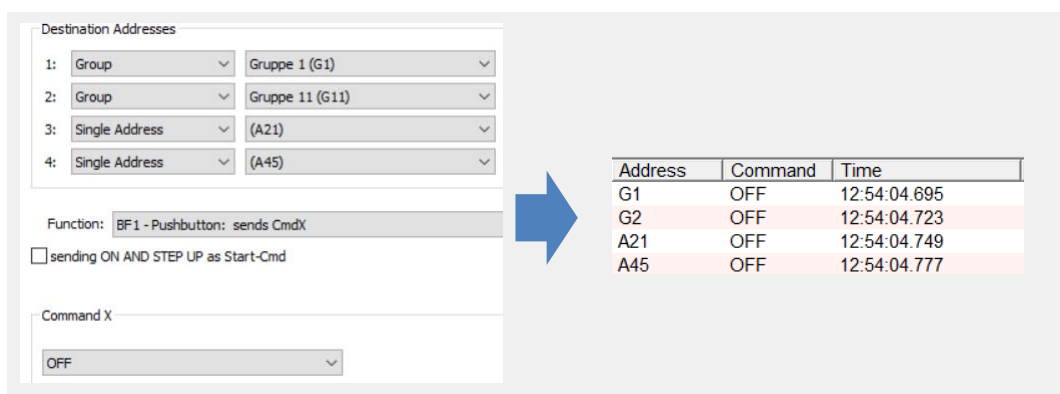

Figure 10 Example: Addressing Inputs 1-4 – sequentially processed

Button Function (BF)

Various "Button Functions" (BF) can be assigned to the individual buttons. The “Button Function” defines the behaviour of a button. A short or long press of the button can trigger different DALI commands.

A toggle function (switching between on and off) is also possible.

For the DALI-2 Touchpanel following "Button Functions" are available, see Figure 11

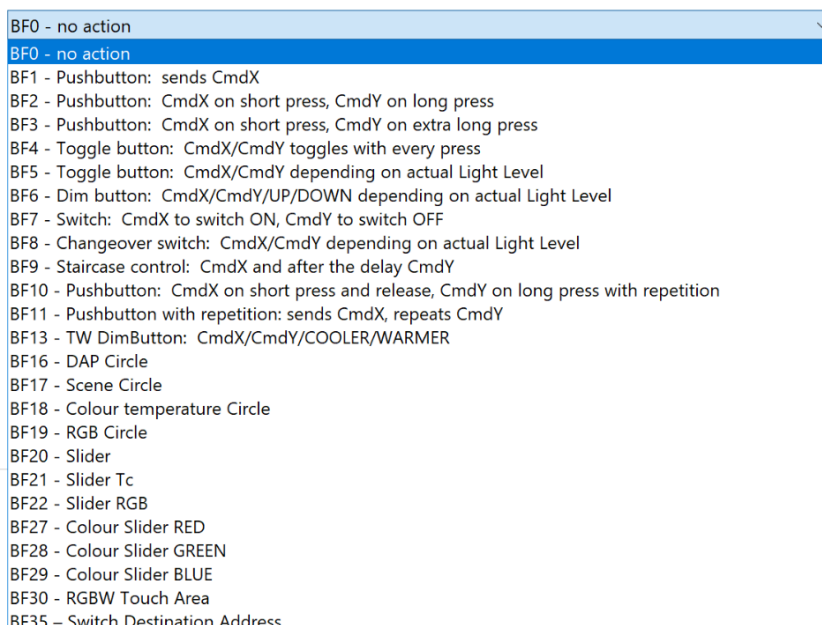



Figure 11 DALI-2 Touchpanel button functions

Key presses (short / long) are queried according to the timing diagram in Figure 12 Key Events and translated into internal signals (**key events**).

The following table (Table 1) shows how the selected “Button Function” (lines 0 to 13)

sends the commands **CmdX** and **CmdY** in connection with the “Key Events” (Figure 12). CmdX and CmdY refer to DALI commands.

 **Note:** The DALI commands are transmitted to all assigned addresses.

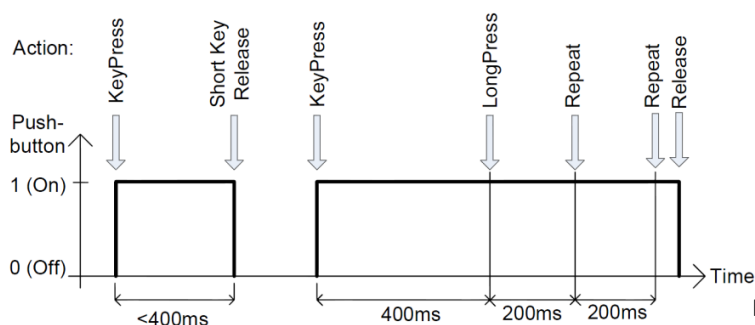
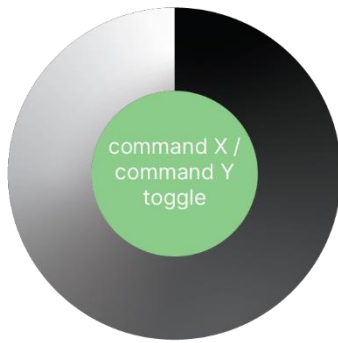

Figure 12 Key Events

button function number	event: press	event: short press (release)	event: long press	event: extra-long press	event: repeat	function	typical application
0	-	-	-	-	-	-	-
1	CmdX	-	-	-	-	sends CmdX on key press	master off
2	CmdX	-	CmdY	-	-	sends CmdX on key press sends CmdY on long key press	switch to 2 different levels
3	-	CmdX	-	CmdY	-	sends CmdX on key press sends CmdY on extra-long key press	store level as scene
4	CmdX / CmdY toggle	-	-	-	-	sends alternating CmdX and CmdY on key press	toggle push button
5	CmdX / CmdY toggle	-	-	-	-	sends CmdX or CmdY on key press depending on bus status	changeover button
6	-	CmdX / CmdY toggle	UP / DOWN	-	UP / DOWN	sends CmdX or CmdY on short key press depending on bus status sends alternating UP or DOWN on long press and repeat	push and dim
7	CmdX CmdY on any release	-	-	-	-	sends CmdX on key press sends CmdY on key release (after any duration)	switch
8	CmdX / CmdY toggle CmdY / CmdX toggle on any release	-	-	-	-	sends CmdX or CmdY on key press depending on bus status sends CmdY or CmdX on key release (after any duration) depending on bus status	changeover switch
9	CmdX CmdY on delay	-	-	-	-	sends CmdX on key press sends CmdY after a programmable delay	staircase control
10	-	CmdX	CmdY	-	CmdY	sends CmdX on short key press sends CmdY on long key press sends CmdY on repeat	push and dim
11	CmdX	-	-	-	CmdY	sends CmdX on key press sends CmdY on repeat	push and dim
13	-	CmdX / CmdY toggle	-	-	WARMER / COOLER	sends CmdX or CmdY on short key press depending on bus status sends alternating WARMER or COOLER on repeat	tunable white dim

Table 1

BF 16 – DAP Circle



BF 17 Scene Circle



BF 18 Colour temperature Circle

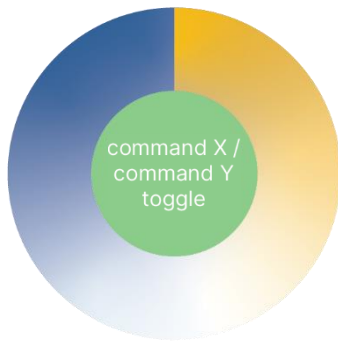

BF 19 RGB Circle



BF 20 Slider

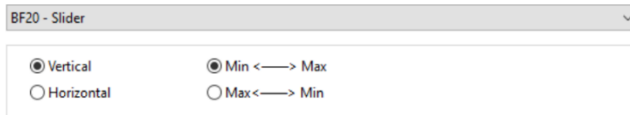
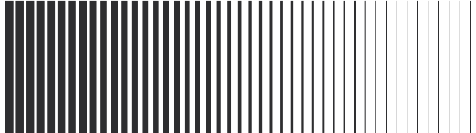

BF 21 Slider Tc

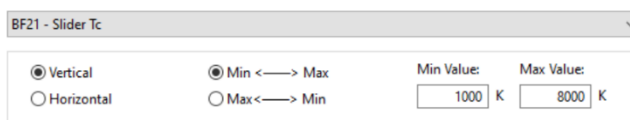
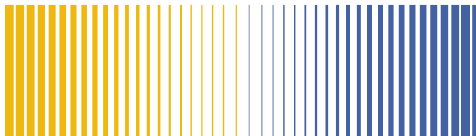

BF 22 Slider RGB

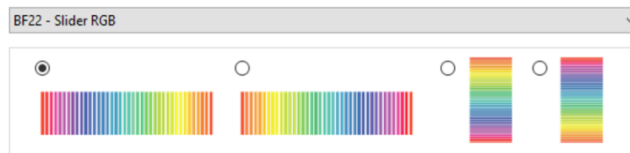
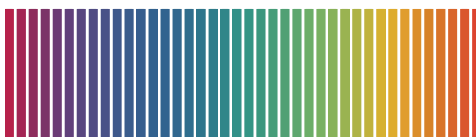

BF 27 Colour Slider RED



BF 28 Colour Slider GREEN



BF 29 Colour Slider BLUE



BF 30 RGBW Touch Area

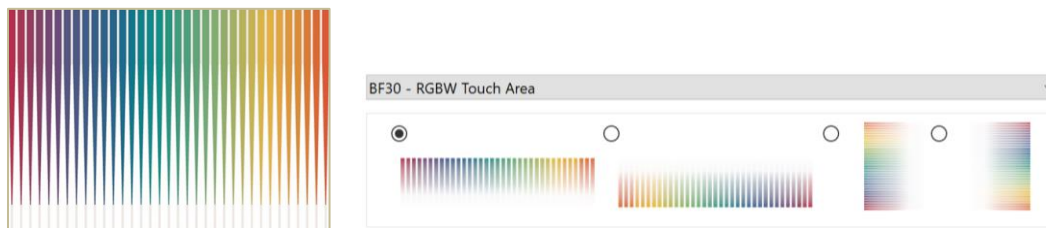

BF 35: Switch destination Address:

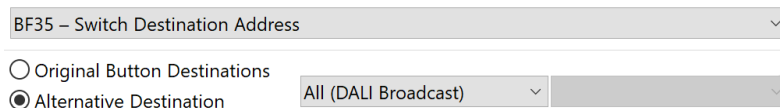

When a button is selected with this function, the effective ranges of all other keys on the touchpanel are switched to the specified effective range.

A button with BF35 and the selection "Original Button Destination" restores the effective ranges of the individual buttons.

With the DALI-2 Touchpanel 04 the state of a switched destination address can be shown via the LED light indicator, see section LED light indicators, page 16

Commands

The actual action, i.e. which function is triggered when pressing a button is determined by the button function and command assigned to the button. For button function 1-13, in most cases, an X command (CmdX) and also a Y command (CmdY) can be selected.

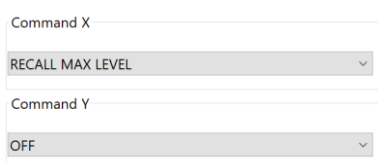

The following options are available:

Command name	action / function
None	no command is sent
DIRECT ARC POWER	direct arc power – set light level in %
OFF	off
UP	dim up (using fade rate)
DOWN	dim down (using fade rate)
STEP UP	increases light level by one increment
STEP DOWN	decreases light level by one increment
RECALL MAX	recalls MAX value

RECALL MIN	recalls MIN value
STEP DOWN AND OFF	decreases light level by one increment, if value at MIN switch off
ON AND STEP UP	increases light level by one increment, if OFF switch on
GOTO LAST ACTIVE LEVEL (DALI 2)	DALI-2-Cmd for switching on to the last active level (Memory-Function) (Firmware 2.0 and up)
GO TO SCENE	go to scene 0-15

Table 2

Depending on the selected command, additional input fields might appear for further settings, see Figure 13.

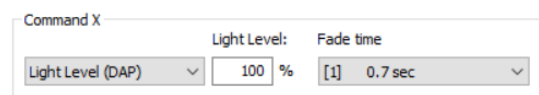

Figure 13 additional settings to a DALI command

Predefined macros

Macros are predefined/ user defined command sequences that can be triggered by a single command.

The following macros are available:

Nr	Macro	Function
M1	Go Home	Light dims down to DAP 0 with predefined fade time, then fade time is set back to a programmable value
M2	Sequential Scenes	A list of the scenes can be defined; the scene is switched with each button press.
M3	Dynamic Scenes	A dynamic sequence of up to 16 scenes can be defined, including custom fade times and delays.
M4	Save actual light level as scene	When triggered the current level is saved in a scene (options: light level, RGB colour value, WAF colour value or colour temperature).
M5	User Defined Cmd-List	A user-defined macro script with up to 19 commands is executed.
M6	TC cooler	Activates the DT8 mode and sends the command "COOLER" 3 times.
M7	TC warmer	Activates the DT8 mode and sends the command "WARMER" 3 times.
M8	Send RGB +	Activates the DT8 mode and sends an ascending RGB colour table value.
M9	Send RGB -	Activates the DT8 mode and sends a descending RGB colour table value.
M10	Delayed Off	Sends a DAP level and after a delay the OFF command. DAP level and delay are user defined.

Table 3

LED light indicators

On the top row of the DALI-2 Touchpanel 04, 4 LEDs are available for configuration.

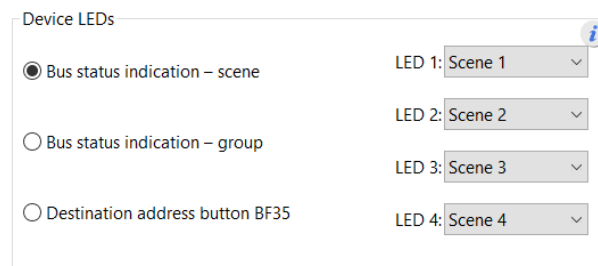

On the left the main functionality selection is made:

- Bus status indication scene: the LED lights up when the configured scene (0-15) is seen Broadcast on the DALI bus, (sent from the DALI-2 Touchpanel itself, or any other control device).
- Bus status indication group: the LED lights up when a DALI control ON command to the configured group (0-15) is seen on the DALI bus (sent from the DALI-2 Touchpanel itself, or any other control device). The LED turns off when an OFF command is sent to the respective group.
- Destination address button BF35: the respective button number of the DALI Touchpanel can be configured. Thereby the LED light up to indicate that a destination address change is active (BF35, see also section Button Function (BF) – BF35).



Figure 14 example LED indication 4 groups active

Palm Control

The first tab on the button tab allows configuration for light control when placing the whole hand on the DALI-2 Touchpanel.



Palm control allows fast light control by placing the entire hand on the DALI-2 Touchpanel. Following buttons functions are available for palm control.

- BF0 – no action – deactivate palm control
- BF1 - Pushbutton: sends CmdX
- BF4 - Toggle button independent of Bus status
- BF5 - Toggle button dependent of Bus status

The same effective ranges and control commands can be configured as for other buttons. The palm control tab cannot be deleted, to turn off palm control select BF0.

DALI-2 Instances

In this operating mode, no DALI control commands are sent on the bus, but DALI-2 event messages for DALI-2 compatible central control systems. General information on DALI-2 Instance mode can be found [here](#).

The DALI-2-Touchpanel supports up to 16 instances of type 1 (IEC62386-301, Input Devices – Push Button), and 5 instances of type 2 (IEC62386-301, Analogue Input Device) which are assigned to the 16 buttons and 5 sliders / circles accordingly.

The number of sliders (BF20-BF22,BF27-BF29) or circles (BF16-BF19) is therefore limited to 5 for the instance mode.

The instances are assigned to the buttons one after the other - see the example below:



Layout

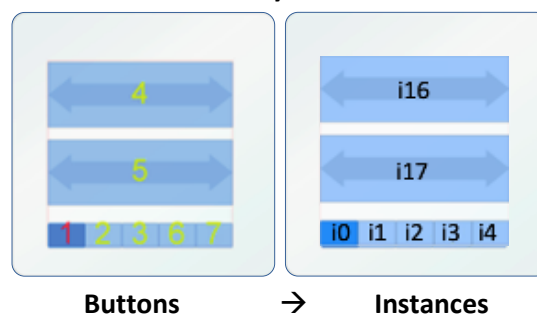

Button1	Pushbutton	BF1	Instance 0
Button2	Pushbutton	BF1	Instance 1
Button3	Pushbutton	BF1	Instance 2
Button4	Slider Tc	BF21	Instance 16
Button5	Slider	BF20	Instance 17
Button6	Pushbutton	BF1	Instance 3
Button7	Pushbutton	BF1	Instance 4
Palm	Pushbutton	BF1	Instance 21

Button – Instance Assignment

 **Attention:** sliders and circles or any other **buttons with analogue instance types need to be configured as buttons 1-5** to ensure the functionality of the analogue instance!

DALI-2 Pushbutton Instance (instance type 1)

As defined in the standard, the following events are supported and sent on the DALI bus as INPUT NOTIFICATIONS, see Table 4

Which events are sent can be determined using the event filter. Further parameters of the instances 0-15 and 21 are: event filter and event timer settings (short timer, double timer, repeat timer, stuck timer), which can be configured via the DALI Cockpit Software, see Figure 15.

Event name	Event Information	Description
Button released	00 0000 0000b	The button is released
Button pressed	00 0000 0001b	The button is pressed
Short press	00 0000 0010b	The button is pressed and released, without being pressed quickly again (in case of double press enabled), or the button is pressed and quickly released (in case double press is disabled)
Double press	00 0000 0101b	The button is pressed and released, quickly

		followed by another button press
Long press start	00 0000 1001b	The button is pressed without releasing it
Long press repeat	00 0000 1011b	Following a long press start condition the button is still pressed, the event occurs at regular intervals as long as the condition holds
Long press stop	00 0000 1100b	Following a long press start condition, the button is released
Button free	00 0000 1110b	The button has been stuck and is now released
Button stuck	00 0000 1111b	The button has been pressed for a very long time and is assumed stuck.

Table 4

Default settings for pushbutton instances:

Assigned Instance groups	None
Event Scheme	Instance addressing
Selected Event Filters	Short press, Long press start Long press repeat Long press stop Button Stuck/free
Short press timer	500ms
Double press timer	- (not used)
Repeat timer	160ms
Stuck Timer	20s

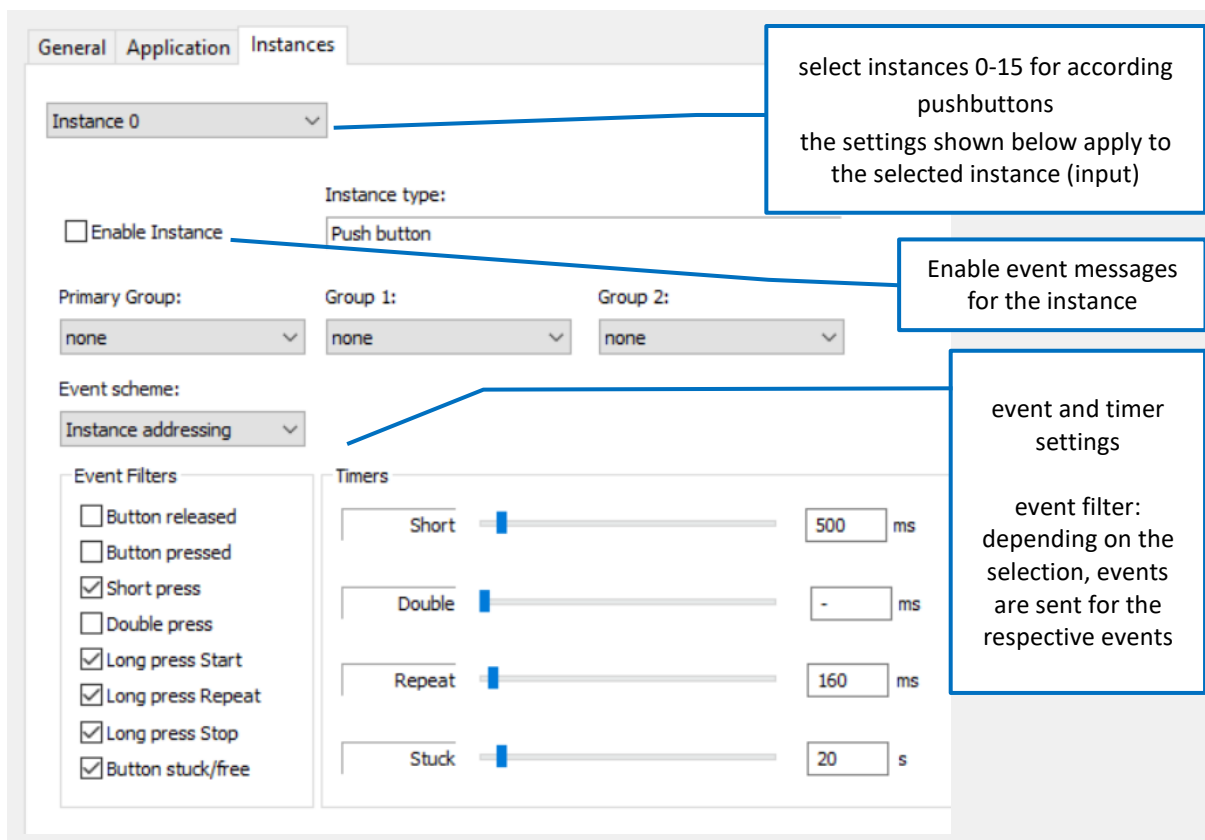

Figure 15 Instance Settings – Pushbutton Instances 0-15

DALI-2 Analog Instance (Instancetype 2)

The event input value of the analogue instance corresponds to the selected position value on the assigned slider or circle. If this value is changed, the instance generates a DALI-2 event ("INPUT NOTIFICATION").

Parameters of the analogue input device instances 16-20 are: event filter and event timer settings (report, deadtime), which can be configured via the DALI Cockpit Software, see Figure 16.

By using the report timer, the input value is sent periodically as a DALI-2 event regardless of input value changes. (Report Timer set to 0s, means no event is sent)

The deadtime can be used to prevent the generation of an event by the instance for the set deadtime-period.

Default Settings for analogue input instances:

Assigned Instance groups	None
Event Scheme	Instance addressing
Selected Event Filters	Position
Event Priority	5 (lowest)
Report timer	255s
Deadtime	12,75s

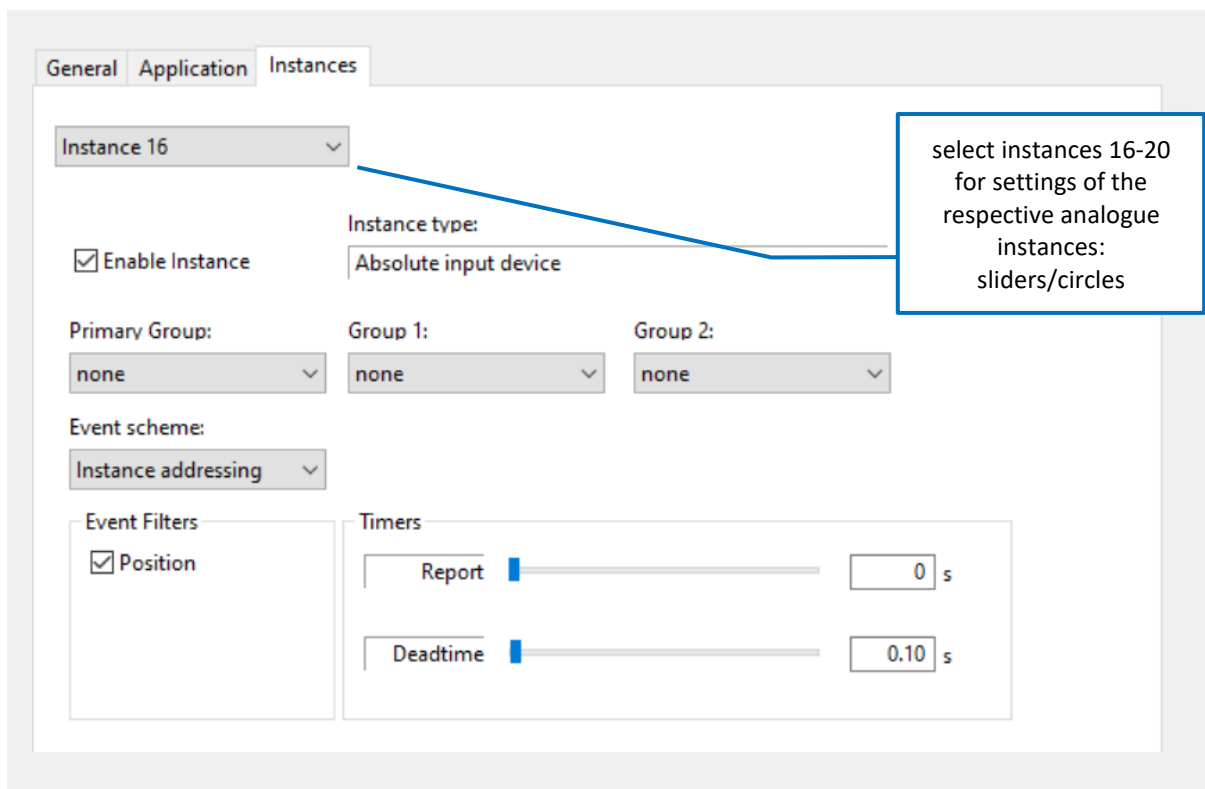
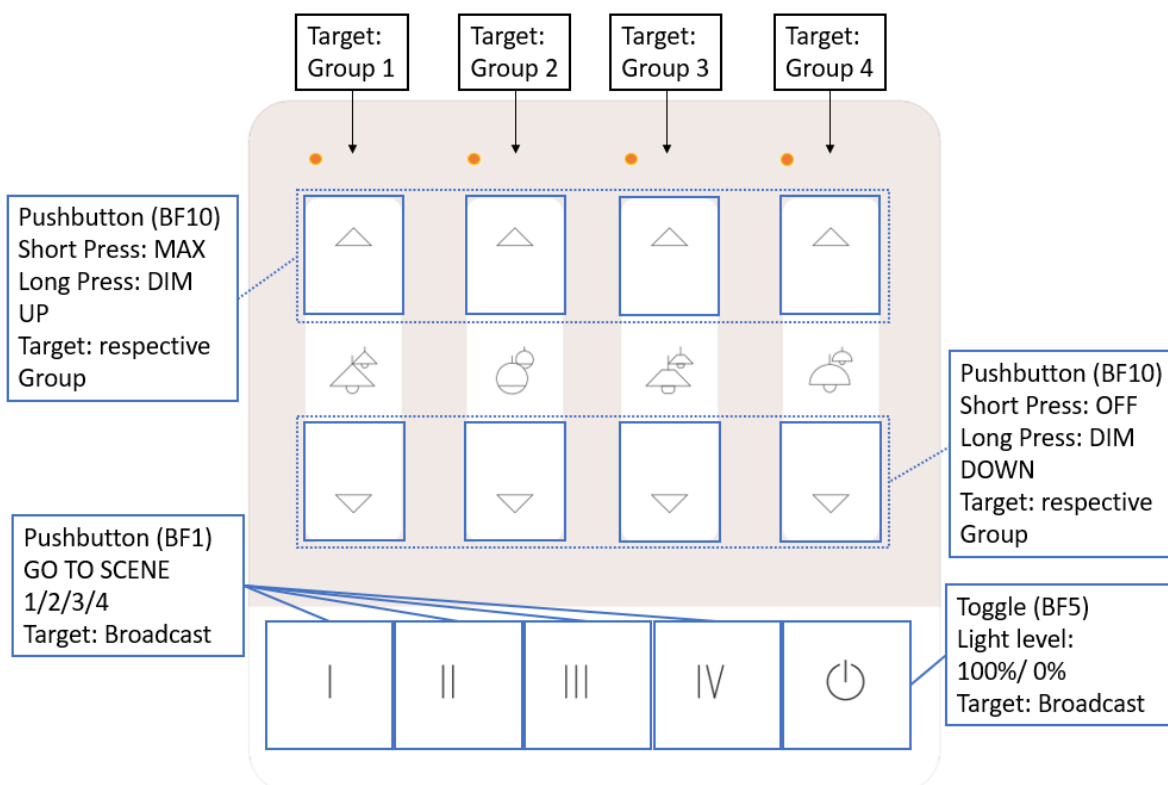
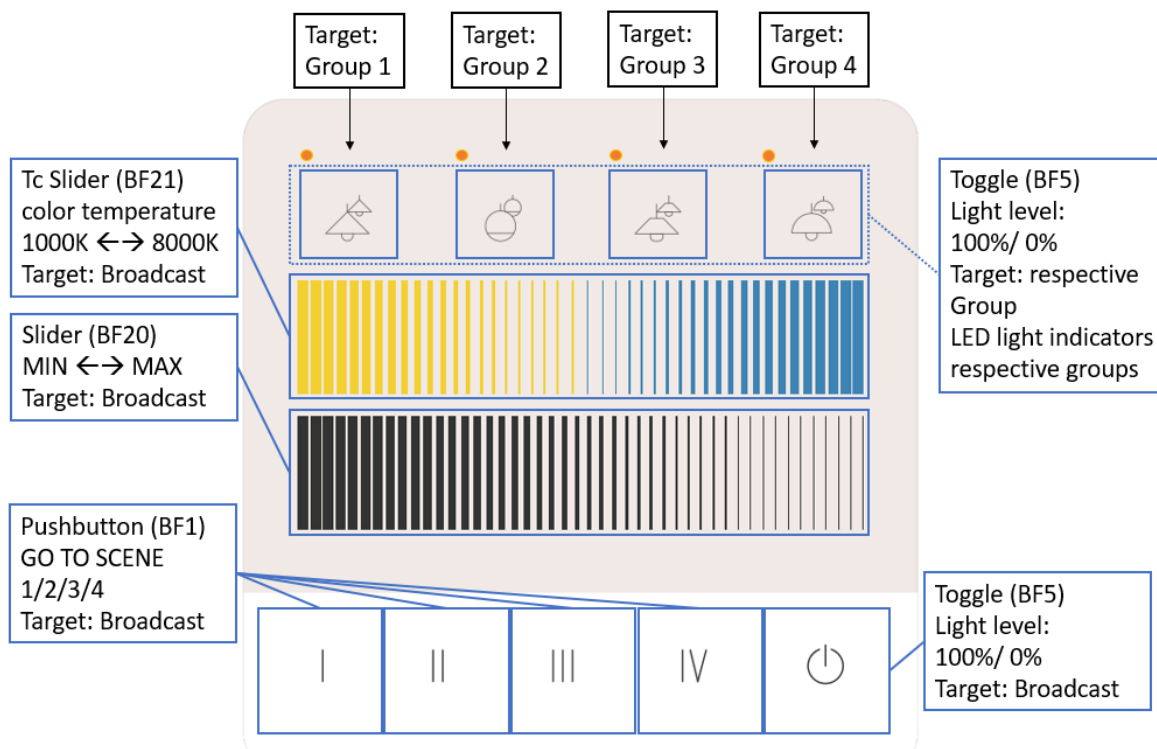

Figure 16 Instance Settings – Analogue Instances 16-20

Standard Layouts – Factory Settings



Layout Art. Nr.: **G10A** 4 groups separately dimmable with arrows



Layout Art. Nr.: **G11A** 4 groups on/off, brightness slider, tunable white slider

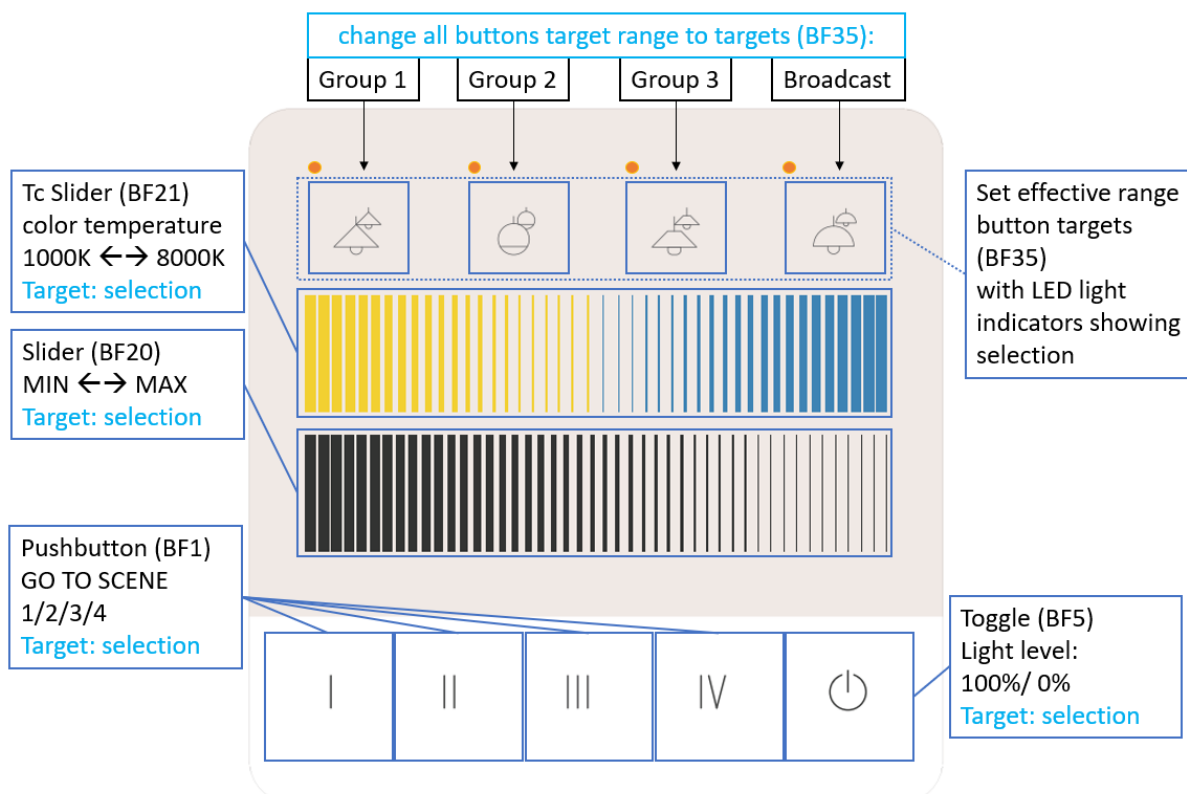

Layout Art. Nr.: **G12A** 4 target selection buttons, brightness slider, tunable white slider

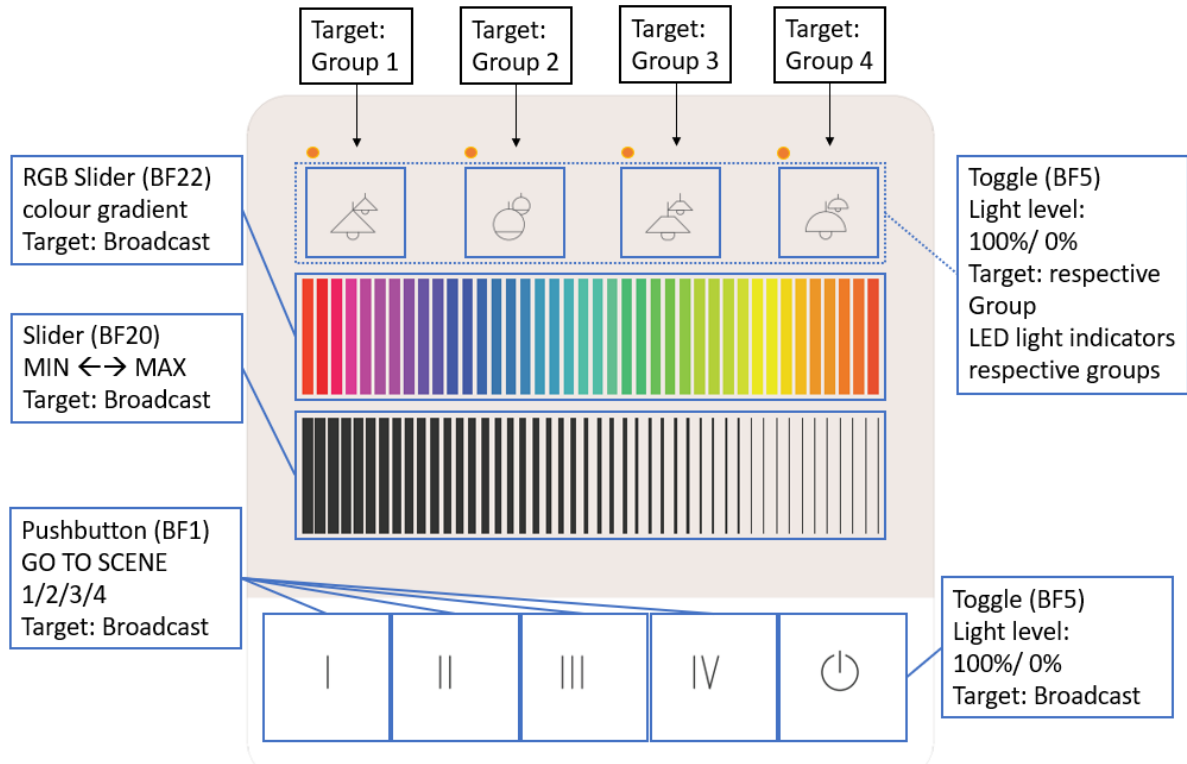

Layout Art. Nr.: G13A 4 groups on/off, brightness slider, RGB slider

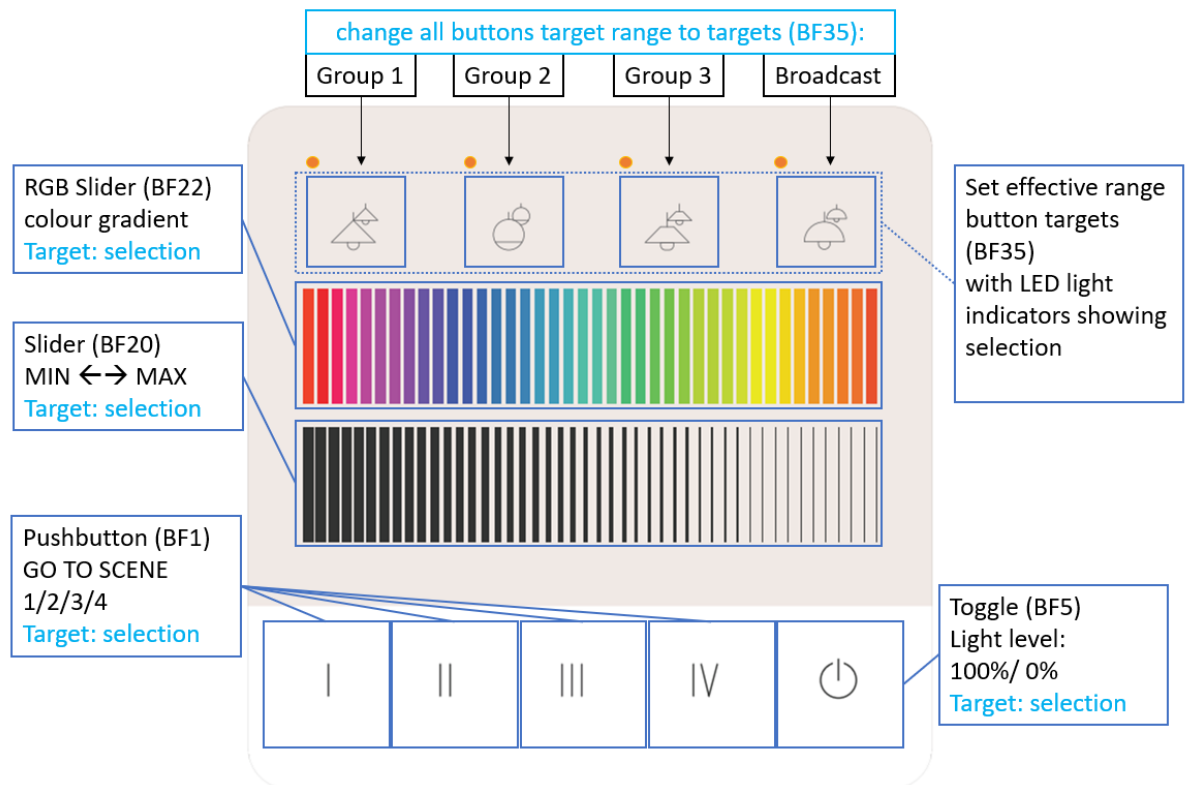

Layout Art. Nr.: G14A 4 target selection buttons, brightness slider, RGB slider

Purchase information

Art. Nr. 24035290-G__

DALI-2 Touchpanel 04
please indicate the desired Layout: G000
G10A to G14A below, or custom.

Art. Nr. 24035290-PS-G__

DALI-2 Touchpanel 04 PS
Version with integrated DALI-PS 70mA
please indicate the desired Layout: G000,
G10A to G08A below, or custom.

Device Version without LEDs: [DALI-2
Touchpanel 03](#)

Online Layout Configurator:

<https://configurator.lunatone.com/touchpanel?lang=en>

Glass Standard layouts

Various layouts, overview:
https://www.lunatone.com/wp-content/uploads/2020/11/DALI-2-Touchpanel-Layouts_EN.pdf

Art. Nr. 24035290-**G000**
unprinted glass

Art. Nr. 24035290-**G10A**
dimming, 4 scenes, 4 groups

Art. Nr. 24035290-**G11A**
dimming, 4 scenes, tunable white, 4
groups

Art. Nr. 24035410-**G12A**
dimming, 4 scenes, tunable white, 4 target
selection buttons

Art. Nr. 24035410-**G13A**
dimming, 4 scenes, colour RGB, 4 groups

Art. Nr. 24035410-**G14A**
dimming, 4 scenes, colour RGB, 4 target
selection buttons

Glass sample sets:

Art. Nr. G000
3 pieces of clear, unprinted glasses

Art. Nr.: G01A - Art. Nr.: G14A
Sample set of 3 pieces of according glasses

Art. Nr.: GMIX5
Set of 5 glasses - please state the desired
article numbers (Art. Nr.: G01A - Art. Nr.:
G14A)

Additional Information and Equipment

Touchpanel Layout configuration files for the DALI cockpit

https://www.lunatone.com/wp-content/uploads/2021/03/TouchpanelLayout_KonfigFiles.zip

DALI Cockpit - free configuration software for DALI systems

<https://www.lunatone.com/en/product/dali-cockpit/>

Lunatone DALI products

<https://www.lunatone.com/en>

Lunatone Datasheets and Manuals

<https://www.lunatone.com/en/downloads-a-z/>

DALI-2 Instancemode Information sheet

https://www.lunatone.com/wp-content/uploads/2021/10/DALI-2_Instance-Guide_EN_M0024.pdf

Contact

Technical Support: support@lunatone.com

Requests: sales@lunatone.com

www.lunatone.com



Disclaimer

Subject to change. Information provided without guarantee. The datasheet refers to the current delivery.

The function in installations with other devices must be tested for compatibility in advance.